





Série 5000 - Profils communs

SILHOUETTE	RÉFÉRENCE ADS	RÉFÉRENCE TOLEDO	DÉSIGNATION	POIDS	PÉRIMÈTRE
	5000	47033	Tapée isolation 100mm	0,466	0,215
	5010	47034	Tapée isolation 120mm	0,557	0,255
	5020	47035	Tapée isolation 140mm	0,649	0,295
	5030	47036	Tapée isolation 160mm	0,741	0,335
	5100	47070	Parclose 23mm	0,267	0,113
	5105	47117	parclose de 20mm	0,257	0,107
	5110	47071	Parclose 18mm	0,251	0,103
	5115	47118	Parclose de 16mm	0,244	0,096
	5120	47072	Parclose 12mm	0,236	0,094
	5130	47073	Parclose 8mm	0,225	0,090
	5150	47150	Parclose 18mm moulurée à clips	0,227	0,091
	5160	47089	Parclose 23 mm arrondie	0,287	0,105
	5170	47090	Parclose 23mm arrondie à clips	0,324	0,106
	5180	47146	Parclose arrondie 18mm à clips	0,280	0,095
	5190	47147	Parclose arrondie 12mm à clips	0,231	0,080
	5200	47046	Couvre-joint 30mm	0,187	0,092

Suite... Série 5000

SILHOUETTE	RÉFÉRENCE ADS	RÉFÉRENCE TOLEDO	DÉSIGNATION	POIDS	PERIMÈTRE
	5210	47047	Couvre-joint 50mm	0,282	0,139
	5220	47048	Couvre-joint 80mm	0,412	0,199
	5230	47056	Bavette 70mm	0,422	0,209
	5240	47057	Bavette 110mm	0,584	0,289
	5300	34065	H de liaison	0,778	0,293
	5400	34035	Raidisseur 40mm	2,118	0,408
	5410	34032	Réhausse 28mm	0,916	0,278
	5420	34033	Réhausse 40mm	1,130	0,303
	5430	34031	Réhausse 60mm	1,474	0,343
	5440	34079	Réhausse 100mm	2,166	0,423
	5500	34036	Raidisseur 60mm	2,719	0,478
	5600	34055	Angle variable gauche	1,066	0,346
	5610	34056	Angle variable droit	1,112	0,368
	5700	47058	Equerre 37mm	4,115	0,378
	5710	47037	Equerre 14mm	3,300	0,317
	5720	47049	Tenon	0,824	0,130

Suite... Série 5000

SILHOUETTE	RÉFÉRENCE ADS	RÉFÉRENCE TOLEDO	DÉSIGNATION	POIDS	PERIMÈTRE
	5730	47119	Équerre variable	0,838	0,213
	5740	47173	Équerre articulée à usiner	1,427	0,231
	5800	47151	Reconstitution de feuillure à visser	0,185	0,096
	5810	47152	Parclose 30mm	0,303	0,121
	5820	47153	Rejet d'eau à clipper	0,404	0,157

Alu Design System

5000

TAPÉE ISOLATION 100mm

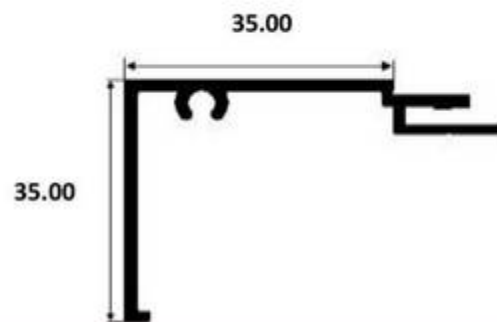

5010

TAPÉE ISOLATION 120mm

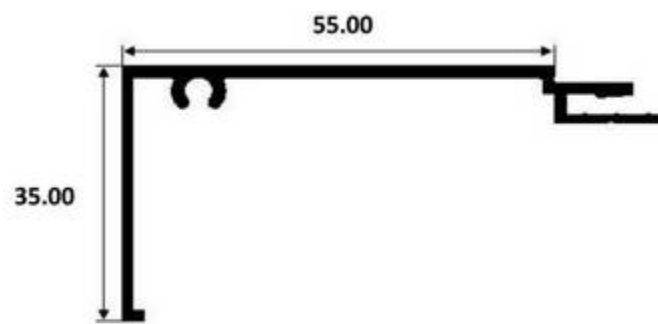

5020

TAPÉE ISOLATION 140mm

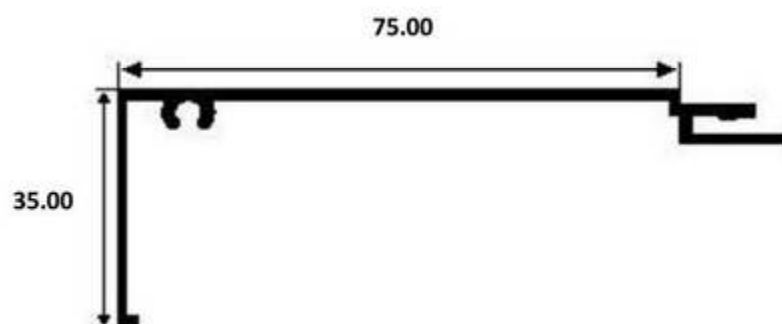

5030

TAPÉE ISOLATION 160mm

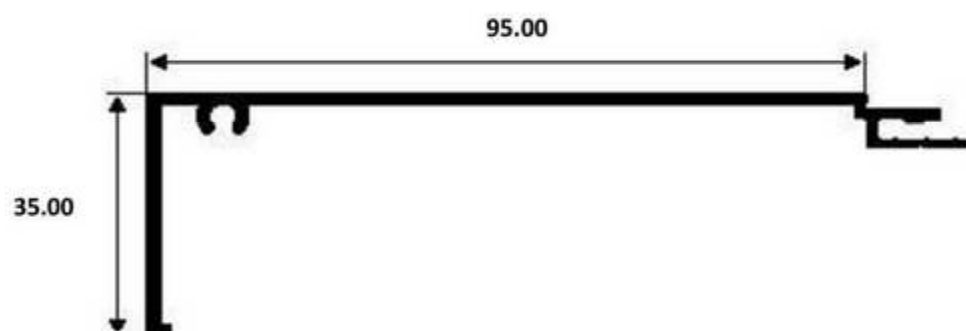

Alu Design System

5100

PARCLOSE 23mm

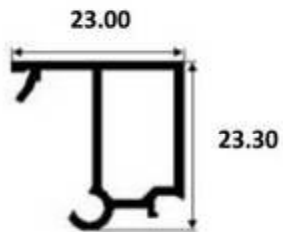

5105

PARCLOSE 20mm

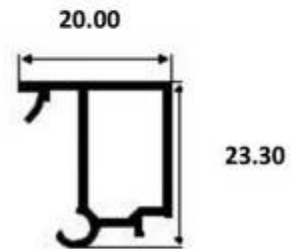

5110

PARCLOSE 18mm

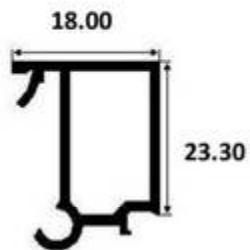

5115

PARCLOSE 16mm

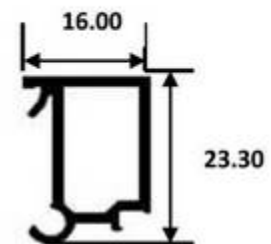

5120

PARCLOSE 12mm

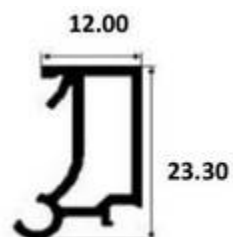

5130

PARCLOSE 8mm

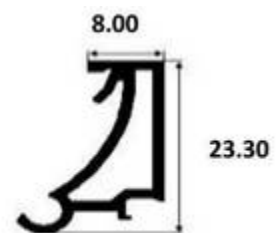

5140

PARCLOSE 18mm MOULURÉE

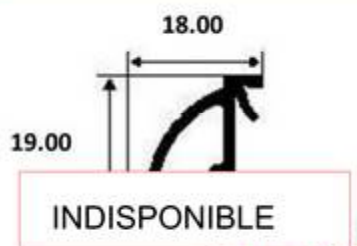

Spécimen à l'étude

5150

PARCLOSE 18mm MOULURÉE À CLIPS

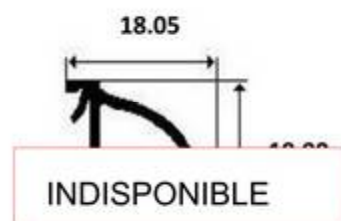

Alu Design System

5160

PARCLOSE ARRONDIE
23mm

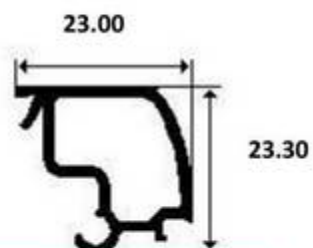

INDISPONIBLE

5170

PARCLOSE ARRONDIE Á
CLIP 23mm

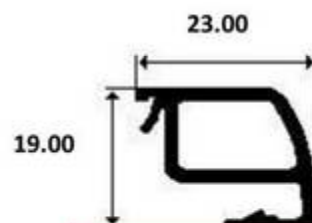

INDISPONIBLE

5180

PARCLOSE ARRONDIE Á
CLIP 18mm

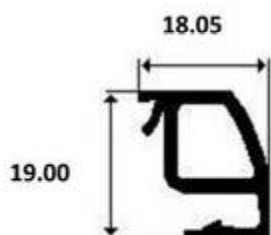

INDISPONIBLE

5190

PARCLOSE ARRONDIE Á
CLIP 12mm

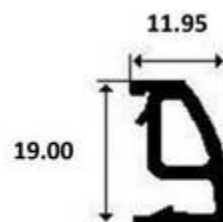

INDISPONIBLE

5200

COUVRE-JOINT 30mm

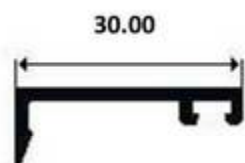

5210

COUVRE-JOINT 50mm

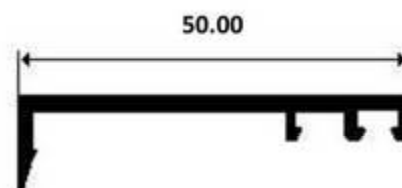

Alu Design System

5220

COUVRE-JOINT 80mm

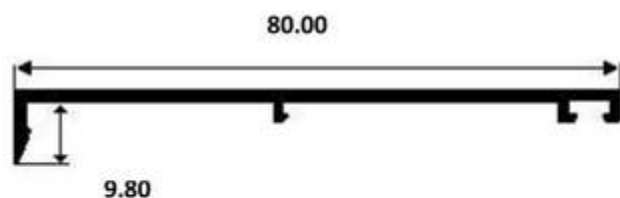

5230

BAVETTE 70mm

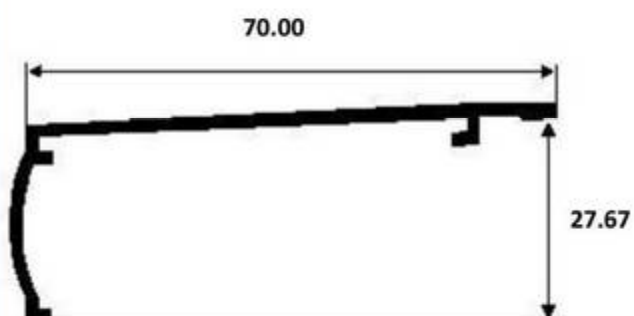

5240

BAVETTE 110mm

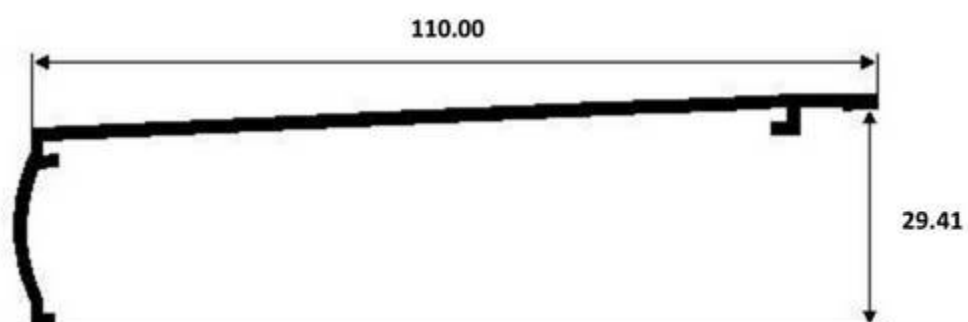

5300

H de LIAISON

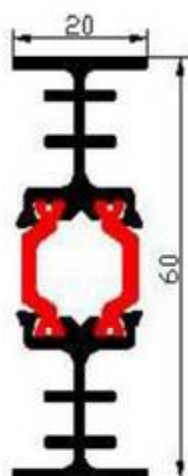

Alu Design System

5400

RAIDISSEUR 40mm

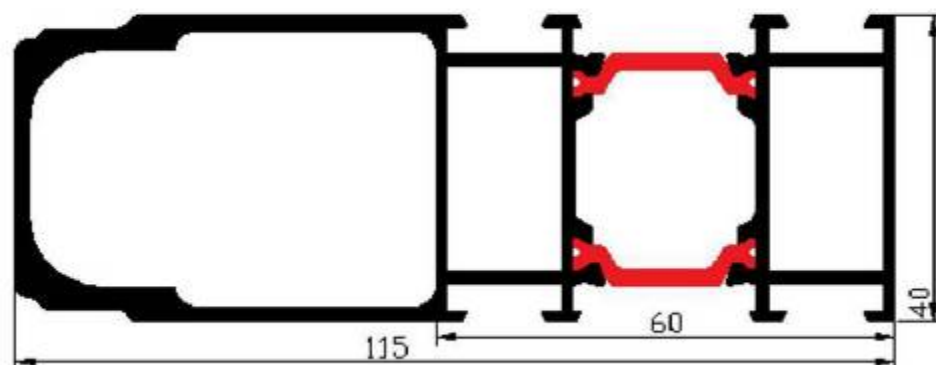

5500

RAIDISSEUR 60mm

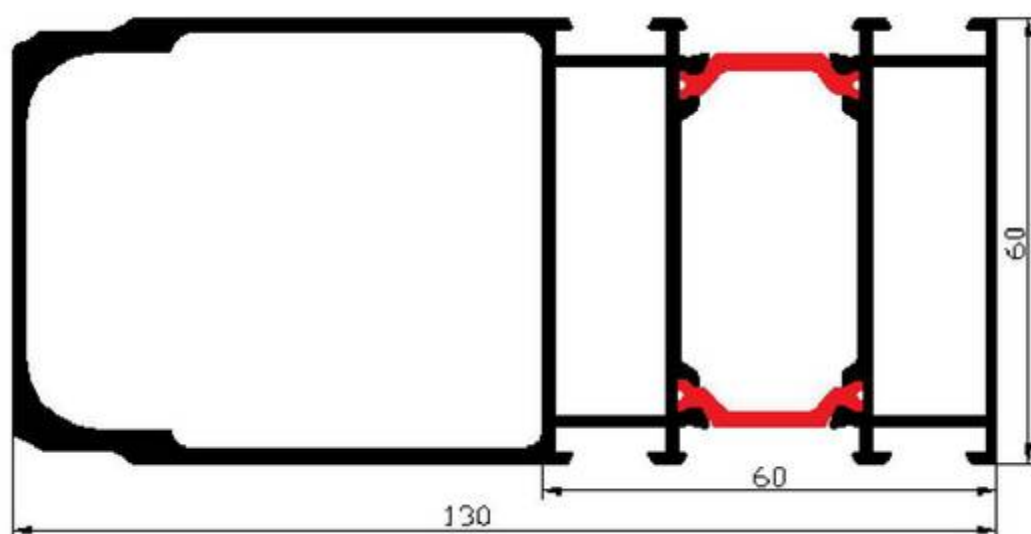

Alu Design System

5410

RÉHAUSSE 28mm

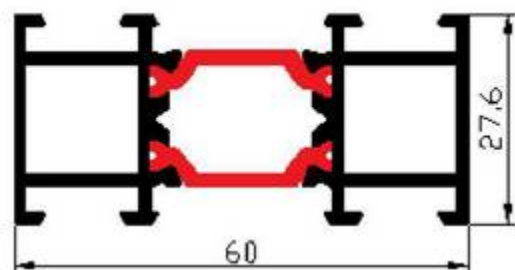

INDISPONIBLE

5420

RÉHAUSSE 40mm

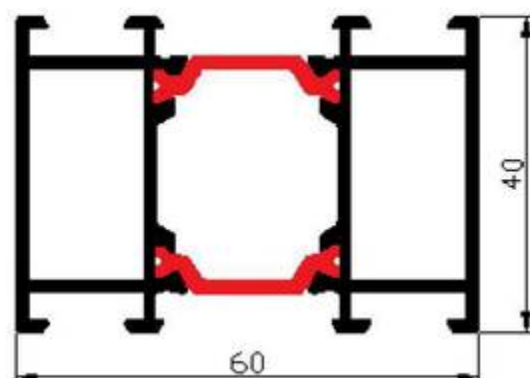

5430

RÉHAUSSE 60mm

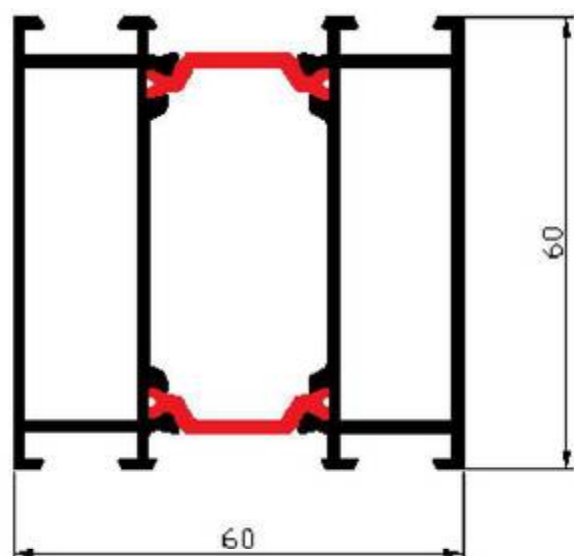

5440

RÉHAUSSE 100mm

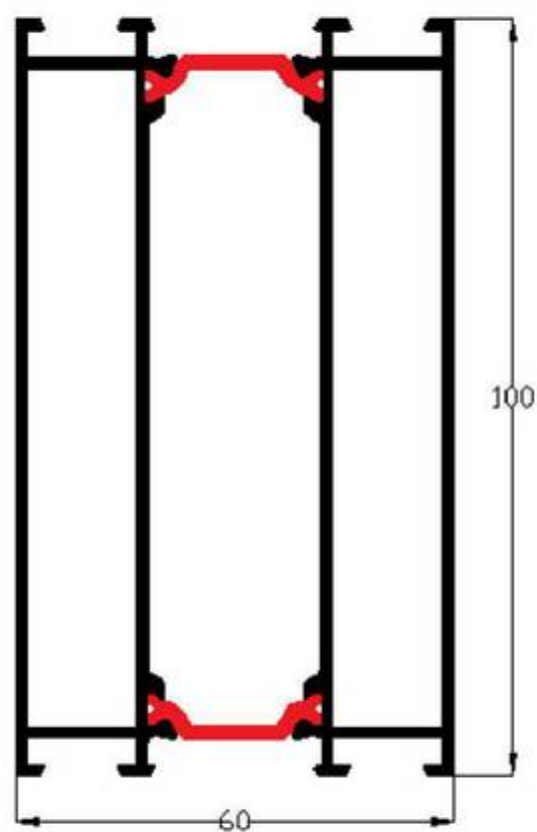

Alu Design System

5600

ANGLE VARIABLE GAUCHE

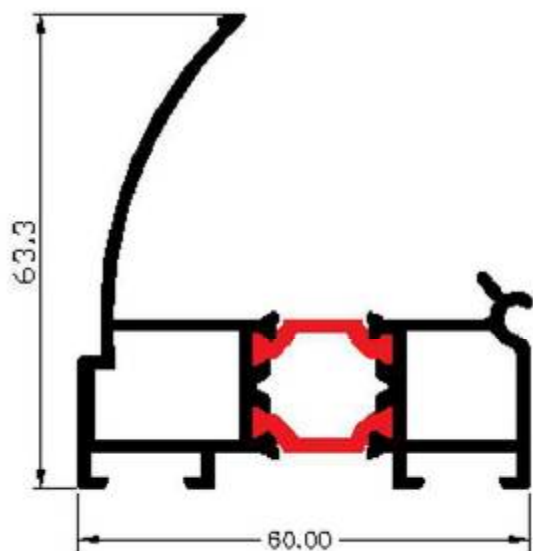

5610

ANGLE VARIABLE DROIT

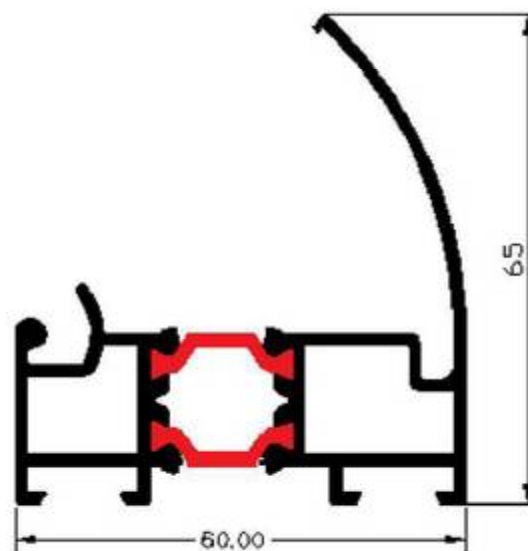

5720

TENON

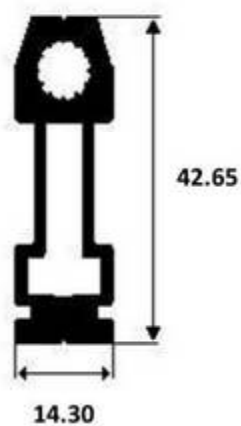

5730

ÉQUERRE VARIABLE

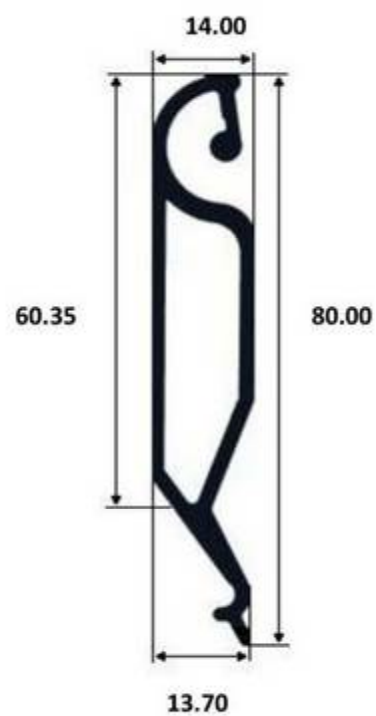

Alu Design System

5700

ÉQUERRE 37mm

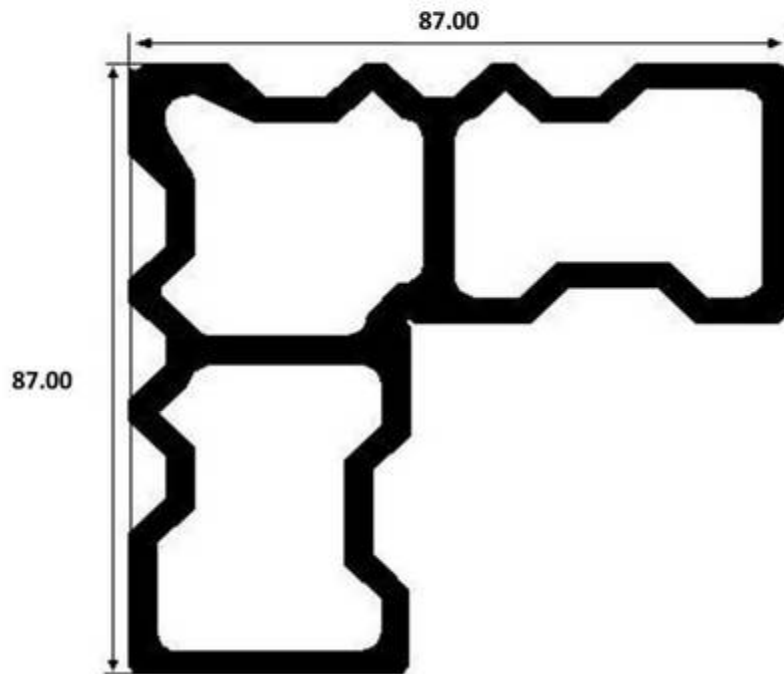

5710

ÉQUERRE 14mm

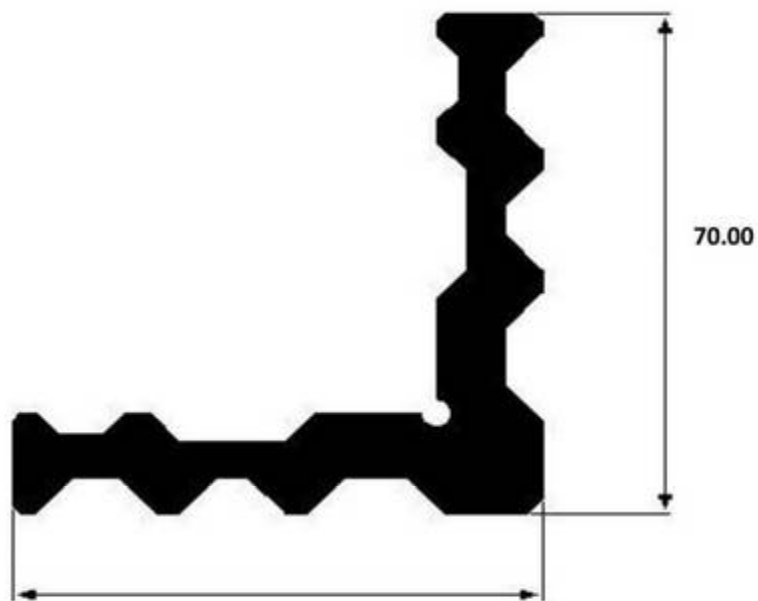

Alu Design System

5740

ÉQUERRE ARTICULÉE À USINER

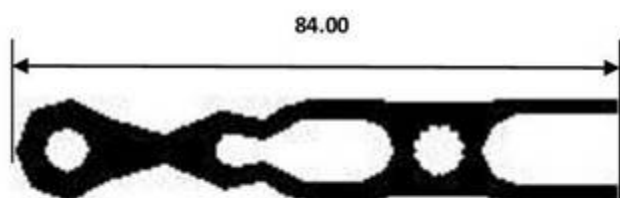

5800

RECONSTITUTION DE FEUILLURE À VISSER

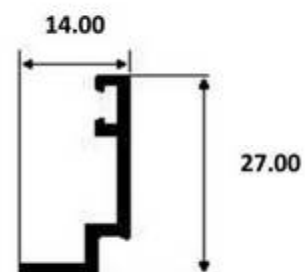

5810

PARCLOUSE DE 30 mm

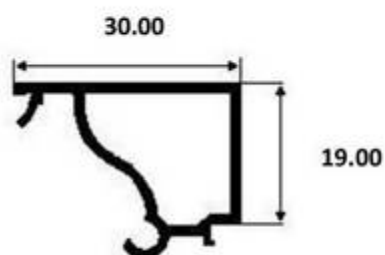

5820

REJET D'EAU À CLIPPER

