

Série 1000 - Châssis à frappe

SILHOUETTE	RÉFÉRENCE ADS	RÉFÉRENCE TOLEDO	DÉSIGNATION	POIDS	PERIMÈTRE
	1000	34047	Dormant plat	1,027	0,335
	1010	34037	Dormant double clips	1,052	0,341
	1020	34048	Dormant couvre-joint intégré	1,131	0,386
	1030	34049	Dormant rénovation	1,254	0,429
	1040	34102	Dormant Clip Intérieur - Plat Extérieur	1,038	0,337
	1100	34042	Ouvrant fenêtre mouluré en Z	1,200	0,382
	1110	34038	Ouvrant fenêtre mouluré en T	1,525	0,480
	1200	34043	Ouvrant droit fenêtre en Z	1,189	0,371
	1210	34039	Ouvrant droit fenêtre en T	1,513	0,472
	1300	34044	Ouvrant porte fenêtre mouluré en Z	1,618	0,428
	1310	34040	Ouvrant porte fenêtre mouluré en T	1,946	0,529
	1400	34045	Ouvrant droit porte fenêtre en Z	1,607	0,417
	1410	34041	Ouvrant droit porte fenêtre en T	1,934	0,518
	1600	34106	Châssis à l'italienne Dormant plat	0,988	0,287
	1610	34107	Châssis à l'italienne Dormant double clips	1,016	0,294
	1620	34108	Châssis à l'italienne Ouvrant de fenêtre	1,406	0,394
	1700	34023	Traverse 72mm	1,143	0,395

suite... Série 1000

SILHOUETTE	RÉFÉRENCE ADS	RÉFÉRENCE TOLEDO	DÉSIGNATION	POIDS	PERIMÈTRE
	1710	34025	Traverse 84mm	1,357	0,420
	1720	34022	Traverse 104mm	1,702	0,460
	1730	34059	Traverse 144mm	2,393	0,538
	1740	34090	Traverse pour Trapèze 84mm	1,357	0,438
	1000-50	34087	Dormant plat Série 50mm	1,027	0,316
	1010-50	34086	Dormant double clips Série 50mm	1,052	0,322
	1000-55	34088	Dormant plat Série 55mm	1,027	0,325
	1010-55	34089	Dormant double clips Série 55mm	1,052	0,330

Série Froide

1000 - Châssis à frappe

SILHOUETTE	RÉFÉRENCE ADS	RÉFÉRENCE TOLEDO	DÉSIGNATION	POIDS	PERIMÈTRE
	1000FR	47140	Série Froide Dormant plat	0,996	0,322
	1010FR	47141	Série Froide Dormant double clips	0,991	0,327
	9800FR	47139	Série Froide Cloisir de 55mm	0,356	0,177

Alu Design System

1000

DORMANT PLAT

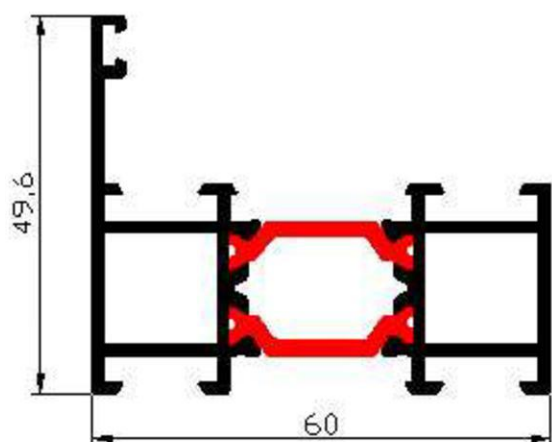

1010

DORMANT DOUBLE CLIPS

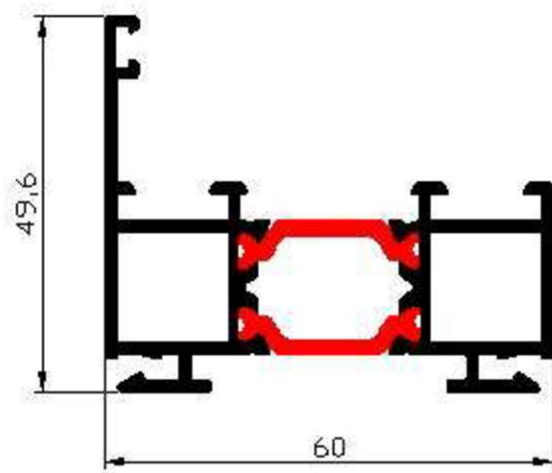

1020

DORMANT COUVRE-JOINT INTÉGRÉ

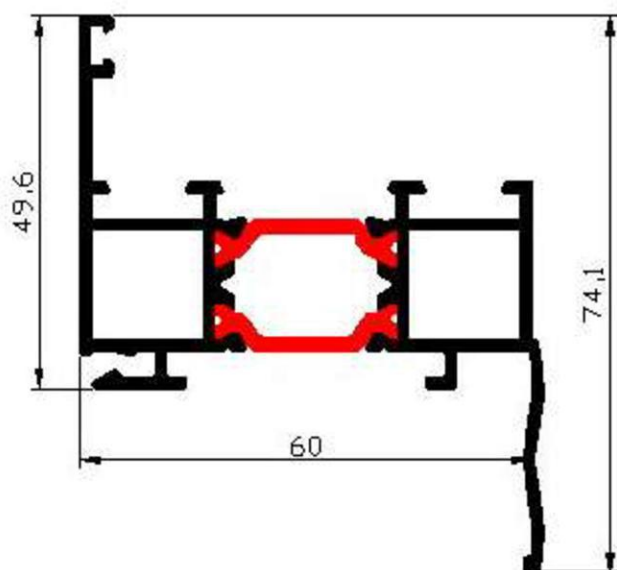

1030

DORMANT RÉNOVATION

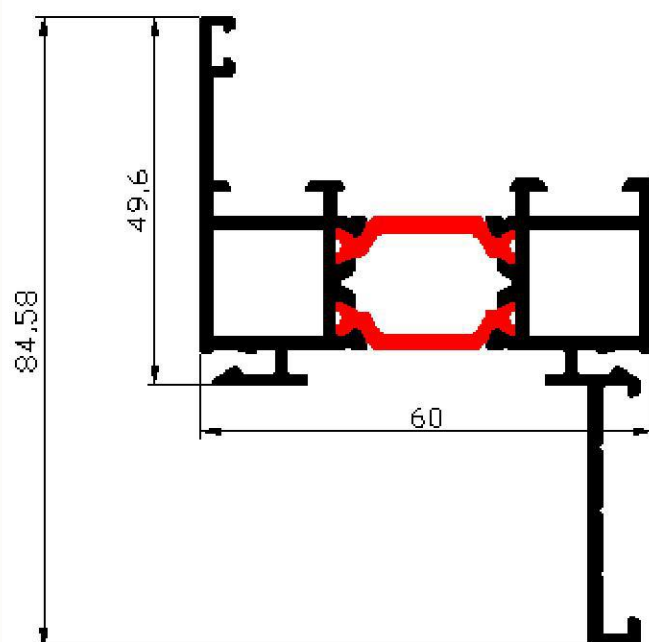

Alu Design System

1040

DORMANT
Clip Intérieur - Plat Extérieur

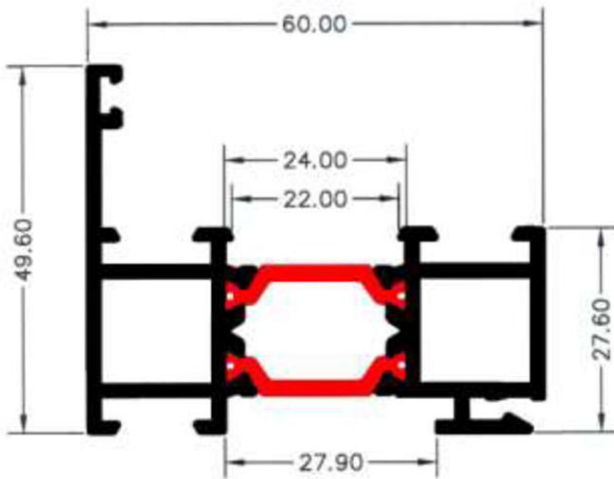

Alu Design System

1000-50

DORMANT PLAT
Série 50

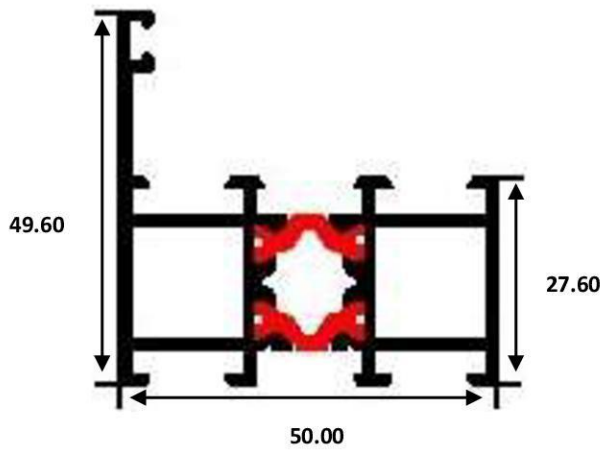

1010-50

DORMANT DOUBLE CLIPS
Série 50

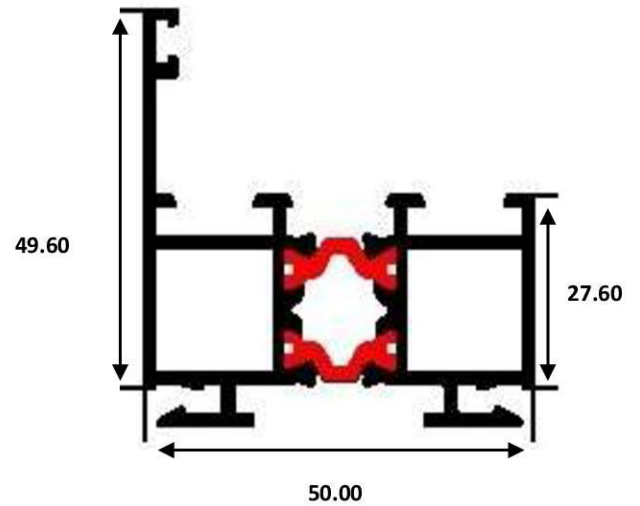

1000-55

DORMANT PLAT
Série 55

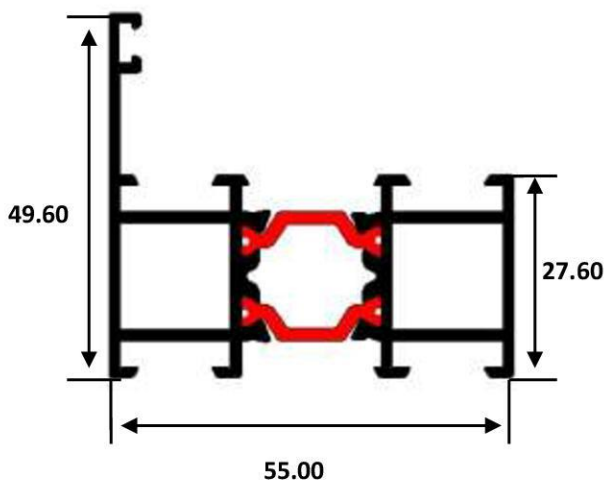

1010-55

DORMANT DOUBLE CLIPS
Série 55

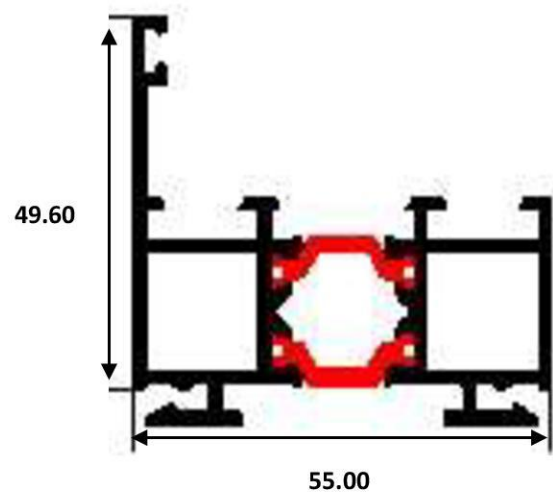

Alu Design System

1100

OUVRANT FENÊTRE
MOULURÉ en Z

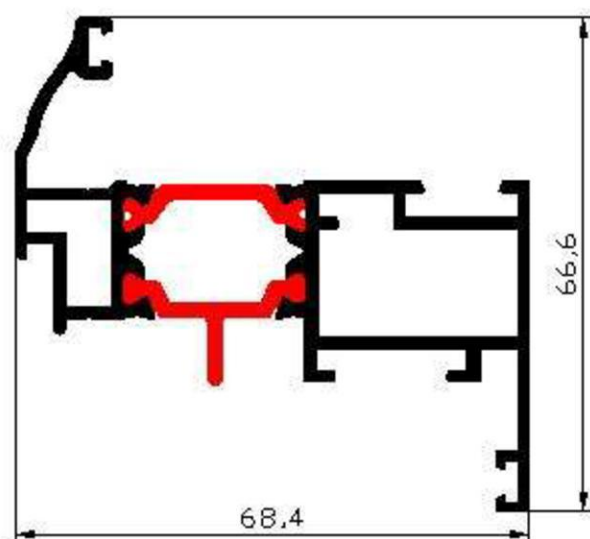

1110

OUVRANT FENÊTRE
MOULURÉ en T

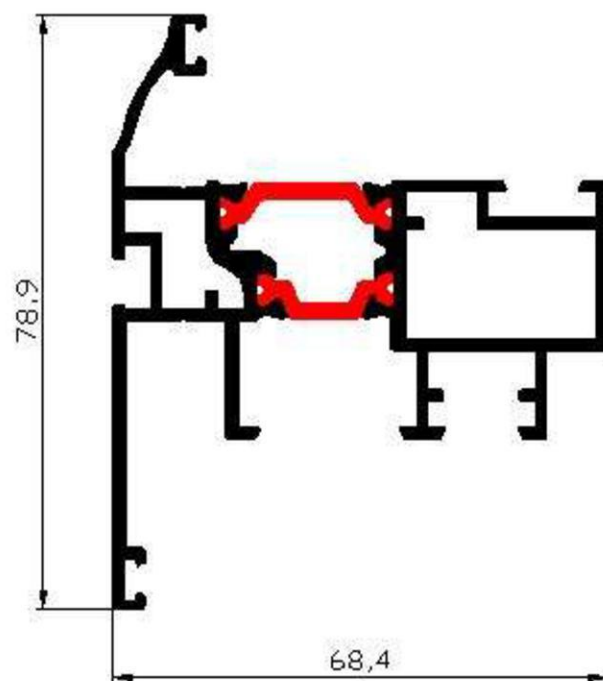

1200

OUVRANT DROIT
FENÊTRE en Z

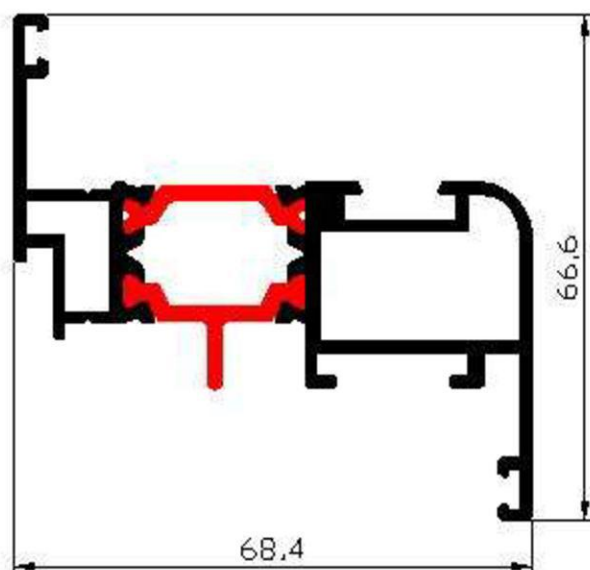

1210

OUVRANT DROIT
FENÊTRE en T

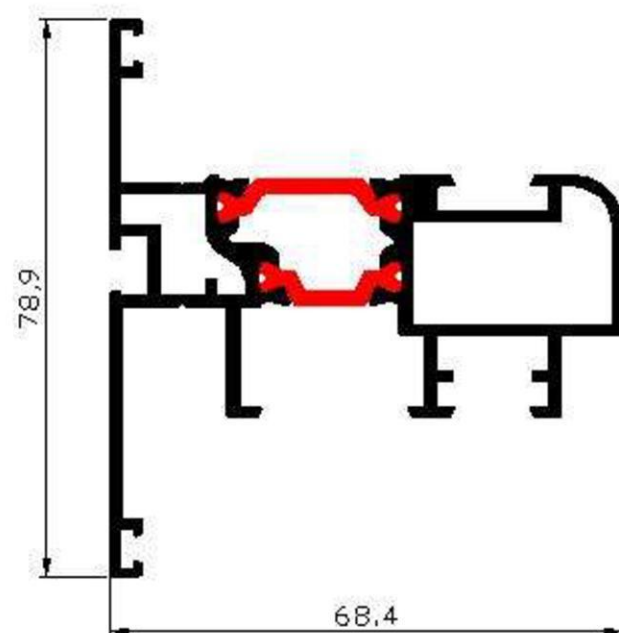

Alu Design System

1300

OUVRANT PORTE FENÊTRE MOULURÉ en Z

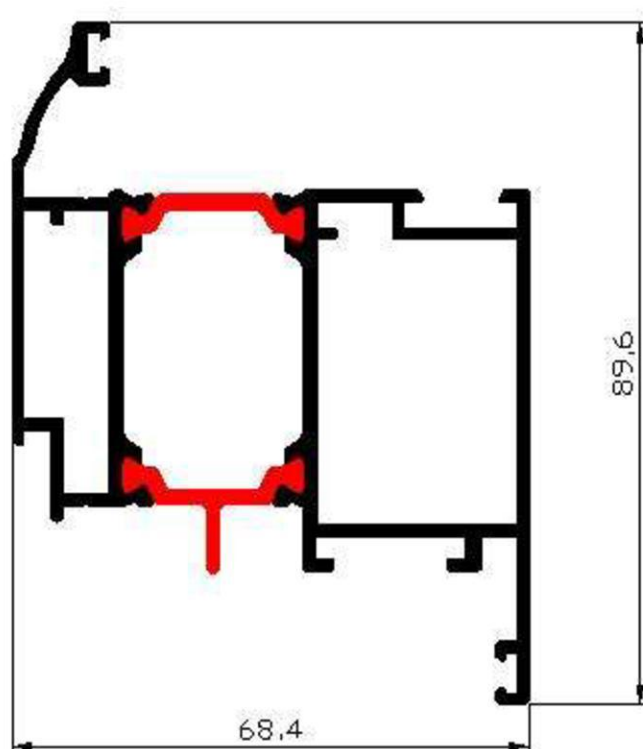

1310

OUVRANT PORTE FENÊTRE MOULURÉ en T

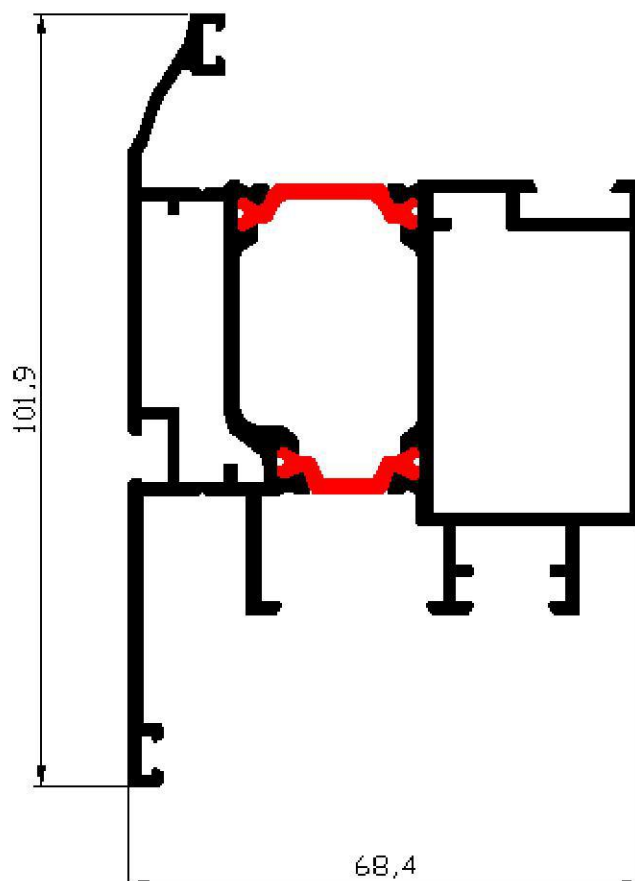

Alu Design System

1400

OUVRANT DROIT PORTE FENÊTRE en Z

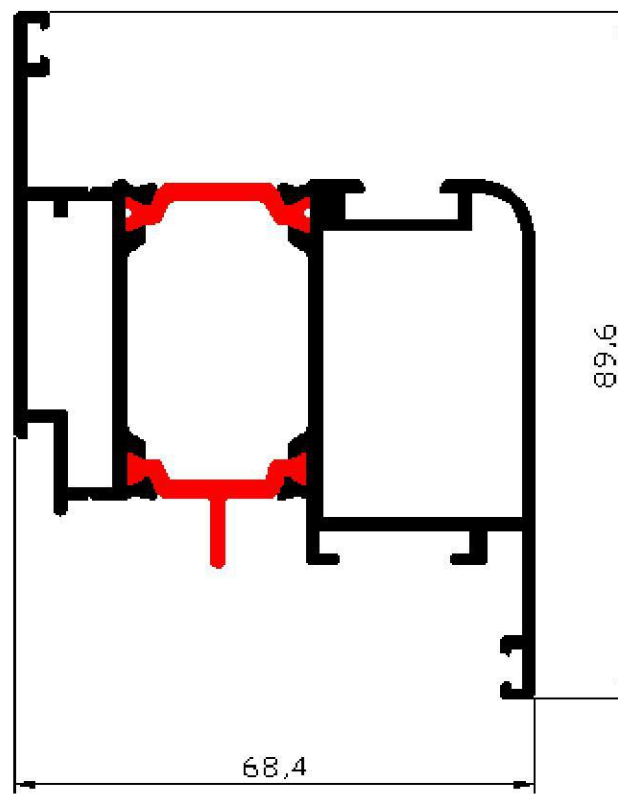

1410

OUVRANT DROIT PORTE FENÊTRE en T

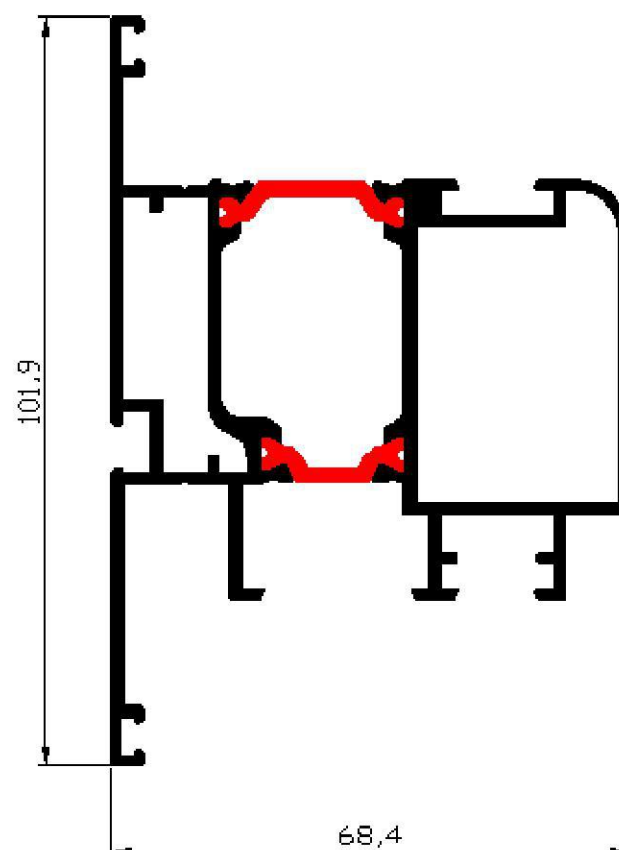

Alu Design System

1600

CHÂSSIS À L'ITALIENNE
DORMANT PLAT

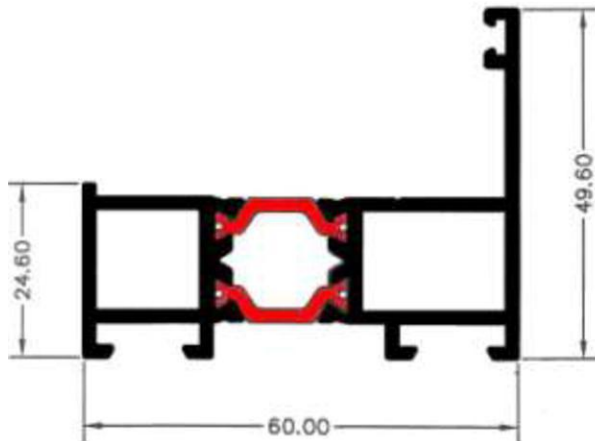

1610

CHÂSSIS À L'ITALIENNE
DORMANT DOUBLE CLIPS

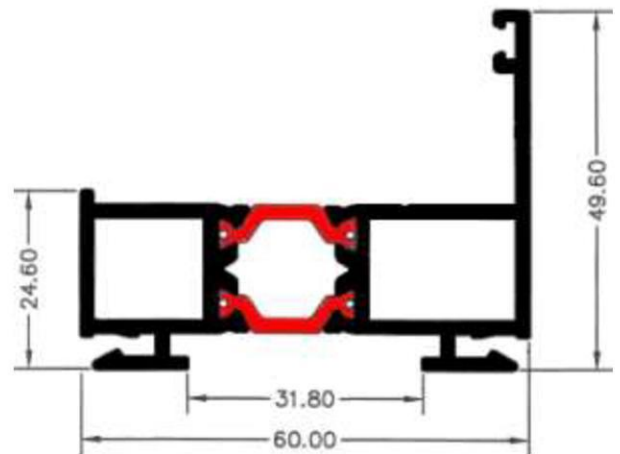

1620

CHÂSSIS À L'ITALIENNE
OUVRANT DE FENÊTRE EN T

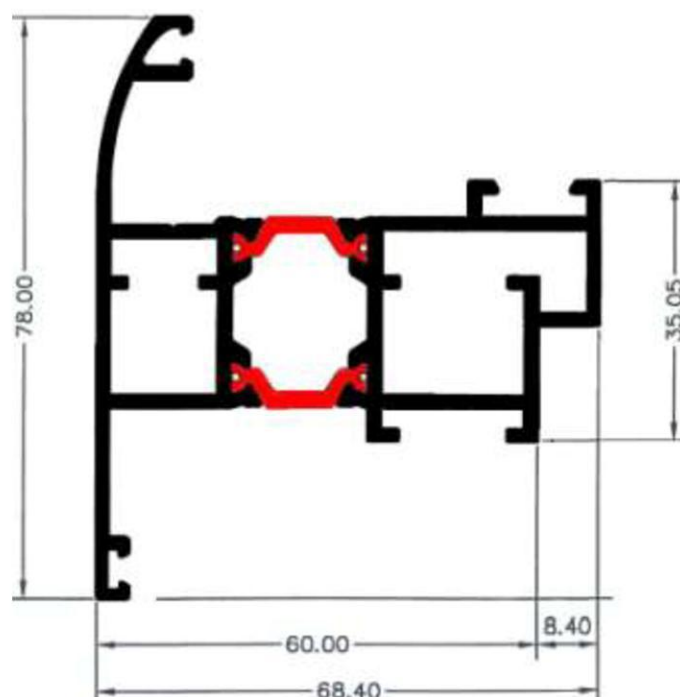

Alu Design System

1700

TRAVERSE 72mm

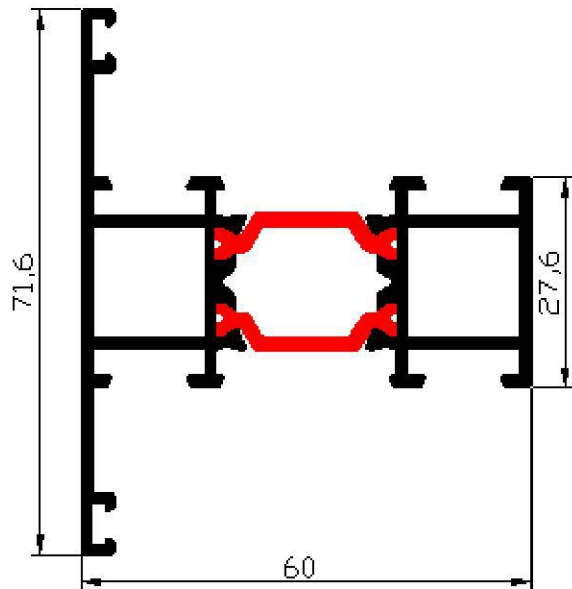

1710

TRAVERSE 84mm

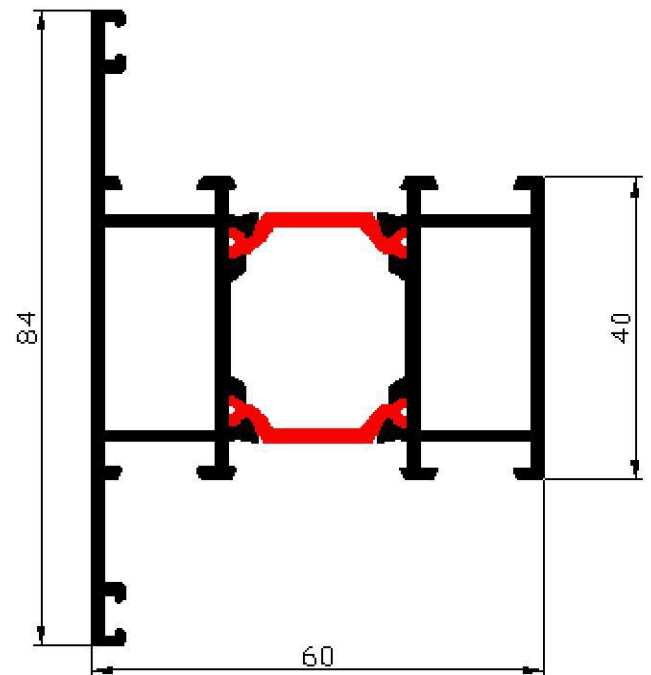

1740

TRAVERSE 84mm
avec alvéolis

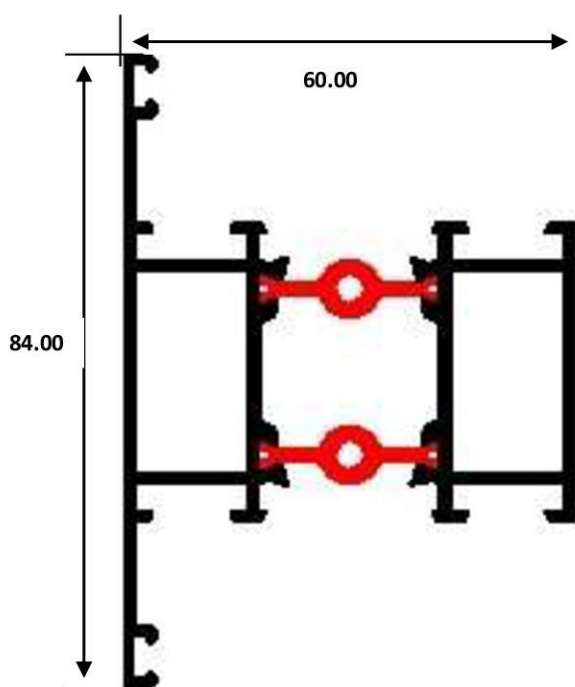

Alu Design System

1720

TRAVERSE 104mm

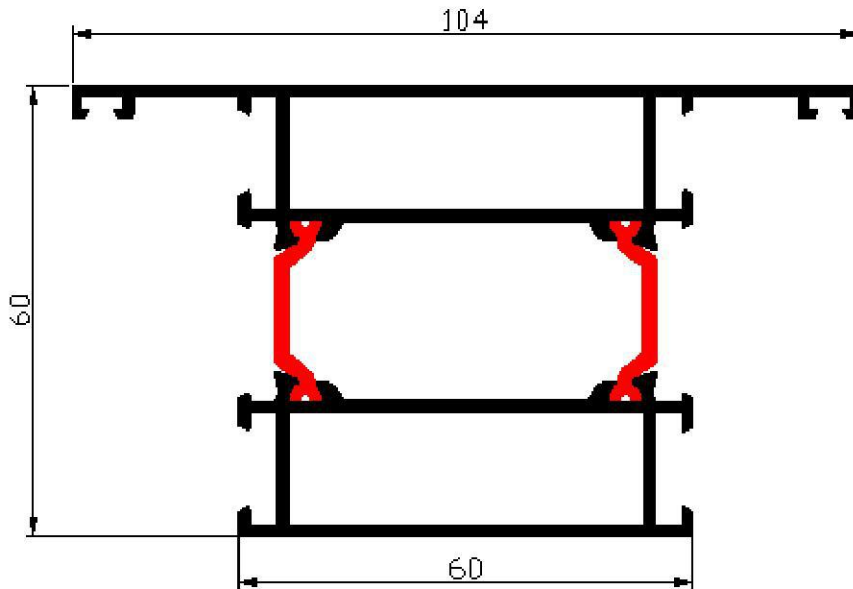

1730

TRAVERSE 144mm

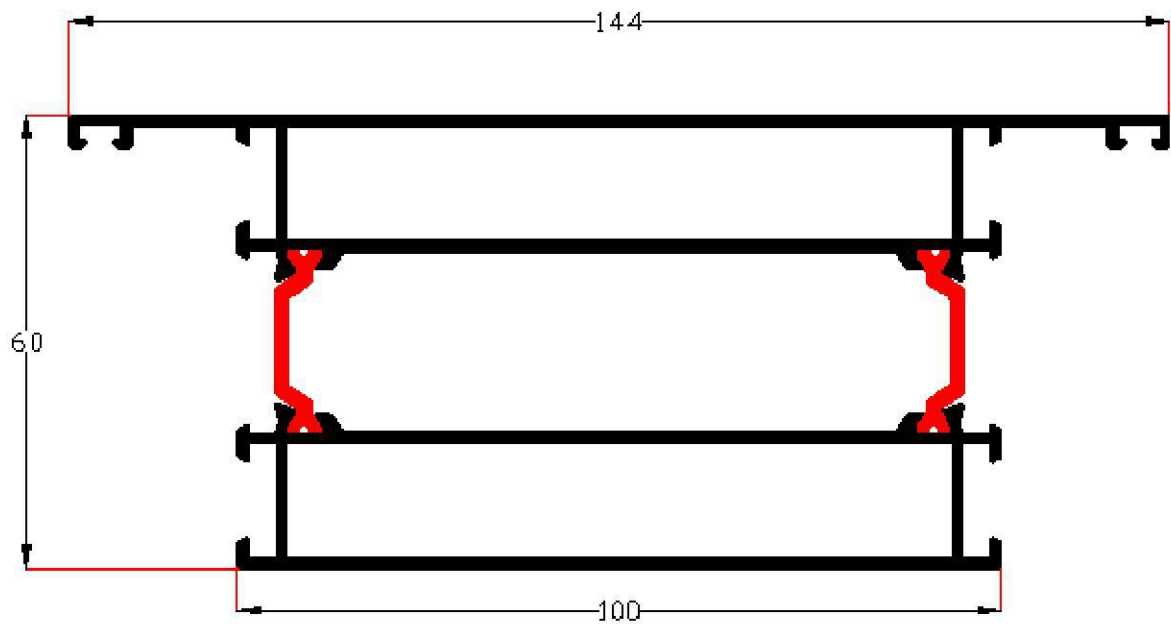

Alu Design System

1000-fr

DORMANT PLAT

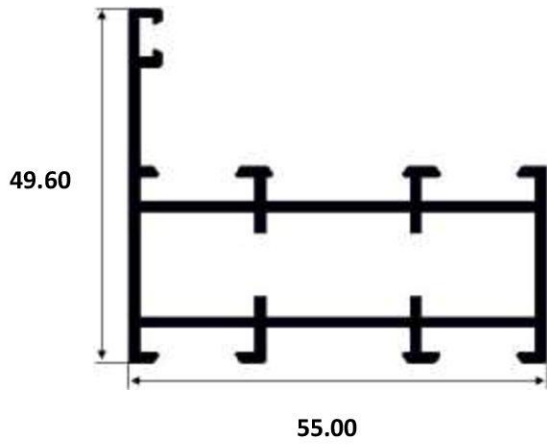

1010-fr

DORMANT DOUBLE CLIPS

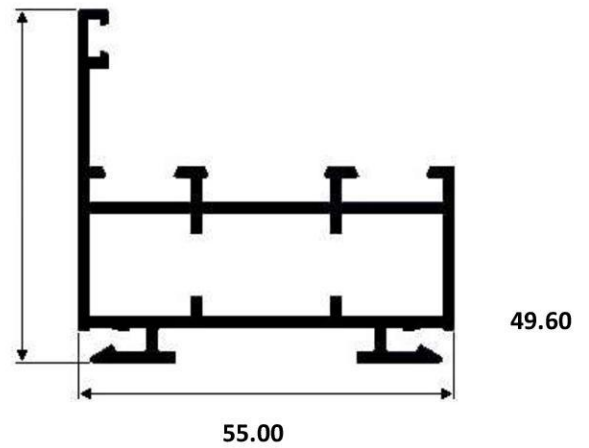



9800-fr





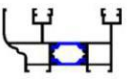
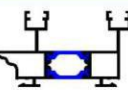
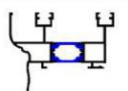
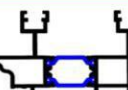
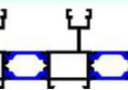
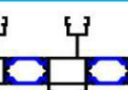
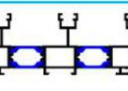
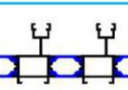
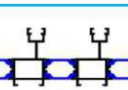
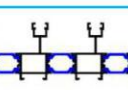
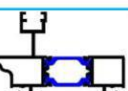
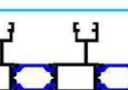
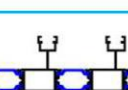

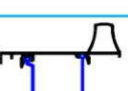
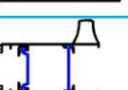



CLOS0IR de 55mm

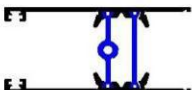
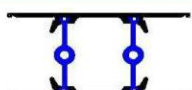

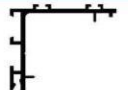
Série 2000 - Châssis coulissant



SILHOUETTE	RÉFÉRENCE ADS	RÉFÉRENCE TOLEDO	DÉSIGNATION	POIDS	PERIMÈTRE
	2000	34000	Dormant coulissant plat	1,414	0,499
	2010	34001	Dormant coulissant double clips	1,442	0,507
	2020	34002	Dormant coulissant couvre-joint intégré	1,521	0,551
	2040	34103	Dormant coulissant Clip Intérieur - Plat Extérieur	1,428	0,502
	2100	34003	Dormant coulissant 3 vantaux plat	2,134	0,730
	2110	34004	Dormant coulissant 3 vantaux double clips	2,162	0,737
	2120	34005	Dormant coulissant 3 vantaux couvre-joint intégré	2,241	0,781
	2200	34006	Dormant coulissant 4 rails plat	2,854	0,960
	2210	34007	Dormant coulissant 4 rails double clips	2,882	0,967
	2220	34008	Dormant coulissant 4 rails couvre-joint intégré	2,961	1,011
	2300	34009	Dormant coulissant 1 vantail galvanage	1,216	0,400
	2310	34010	Dormant coulissant 2 vantaux galvanage	1,936	0,630
	2320	34011	Dormant coulissant 3 vantaux galvanage	2,656	0,967
	2400	34012	Montant serrure coulissant	1,152	0,417
	2410	34013	Montant serrure renforcé	1,333	0,445
	2420	34014	Montant serrure coulissant double renforts	1,514	0,473

suite... Série 2000

SILHOUETTE	RÉFÉRENCE ADS	RÉFÉRENCE TOLEDO	DÉSIGNATION	POIDS	PERIMÈTRE
	2500	47007	Chicane simple	0,645	0,189
	2510	47008	Chicane simple renforcée	0,887	0,214
	2520	47009	Chicane renforcée	1,173	0,242
	2530	34016	Traverse coulissant	0,926	0,41
	2540	34015	Traverse intermédiaire coulissant	0,850	0,33
	2600	47014	Extention intermédiaire galvanage	1,110	0,336
	2610	47015	Etanchéité extérieure galvanage	0,671	0,282
	2620	47016	Capot extérieur galvanage	0,371	0,195
	2630	47017	Profil complémentaire galvanage intérieur	0,597	0,176
	2640	47018	Profil intermédiaire galvanage	0,809	0,223
	2650	47019	Jonction 4 vantaux coulissant	0,410	0,140
	2660	47020	Rail coulissant	0,140	0,064
	2670	47021	Cornière habillage	0,519	0,230

Série Froide

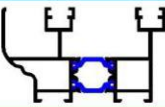
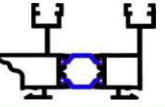
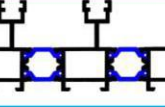
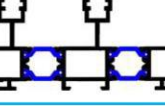
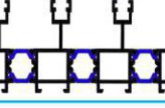
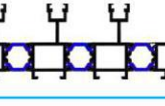
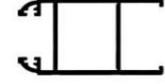
2000 - Châssis coulissant

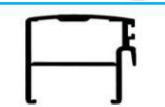
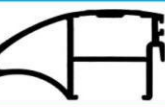
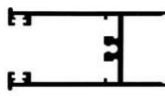
SILHOUETTE	RÉFÉRENCE ADS	RÉFÉRENCE TOLEDO	DÉSIGNATION	POIDS	PERIMÈTRE
	2000FR	34109	Série Froide Dormant plat de coulissant	1,414	0,489
	2010FR	34110	Série Froide Dormant double clips de coulissant	1,442	0,496
	2100FR	34111	Série Froide Dormant plat coulissant 3 vantaux	2,134	0,710
	2110FR	34112	Série Froide Dormant double clips coulissant 3 vantaux	2,162	0,717
	2200FR	34113	Série Froide Dormant plat coulissant 4 rails	2,854	0,930
	2210FR	34114	Série Froide Dormant double clips coulissant 4 rails	2,882	0,937
	2400FR	47194	Série Froide Montant serrure coulissant	0,934	0,312
	2410FR	47195	Série Froide Montant serrure renforcé	1,116	0,340
	2500FR	47196	Série Froide Chicane simple	0,792	0,225
	2520FR	47197	Série Froide Chicane renforcée	1,332	0,279
	2530FR	47198	Série Froide Traverse coulissant	0,865	0,385

Alu Design System

2000

DORMANT COULISSANT

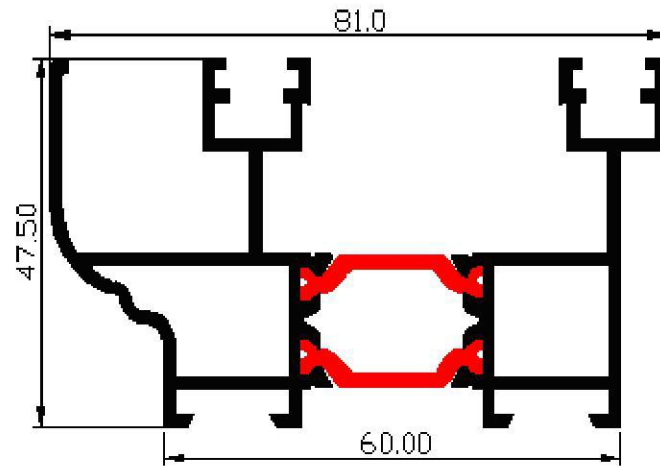

2010

DORMANT COULISSANT DOUBLE CLIPS

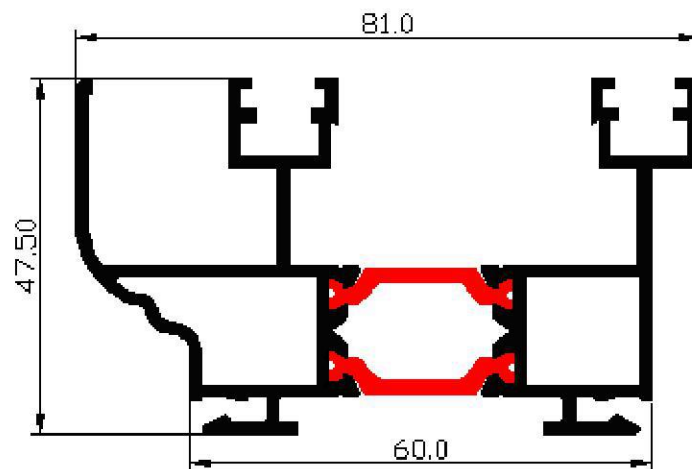

Alu Design System

2020

DORMANT COULISSANT COUVRE-JOINT INTÉGRÉ

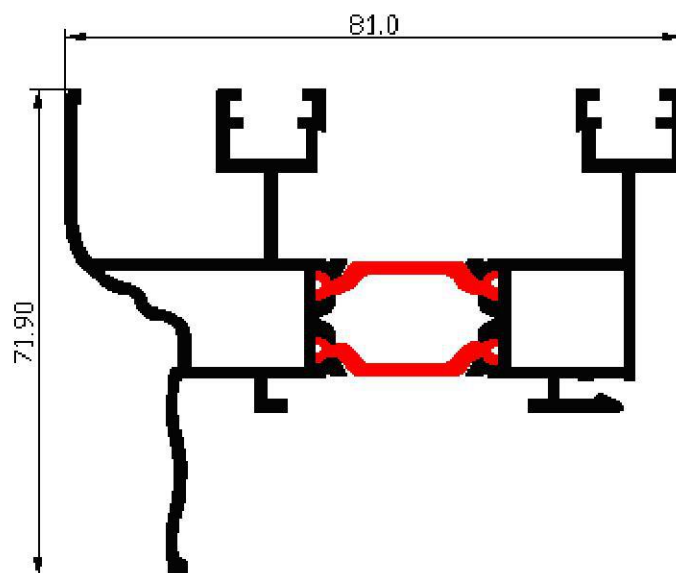

2040

DORMANT COULISSANT Clip Intérieur – Plat Extérieur

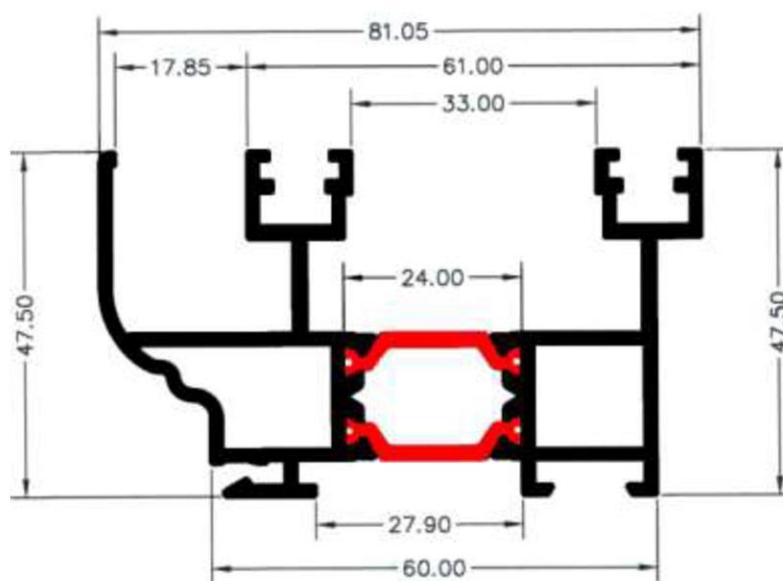

Alu Design System

2100

DORMANT COULISSANT 3 VANTAUX - PLAT

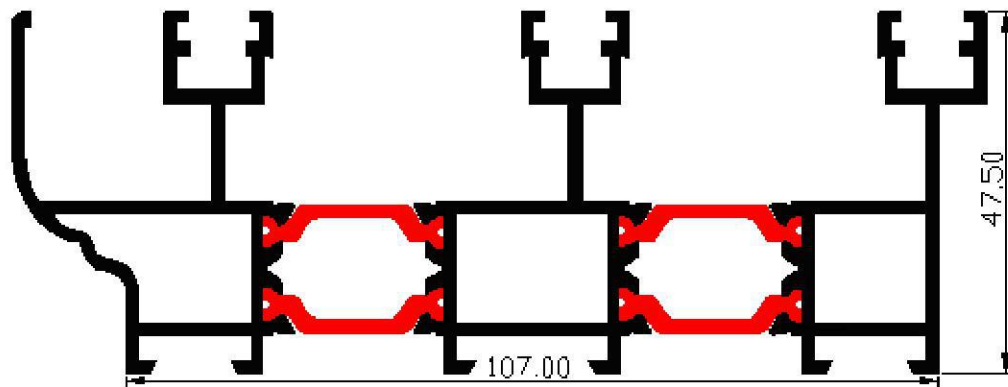

2110

DORMANT COULISSANT 3 VANTAUX DOUBLE CLIPS

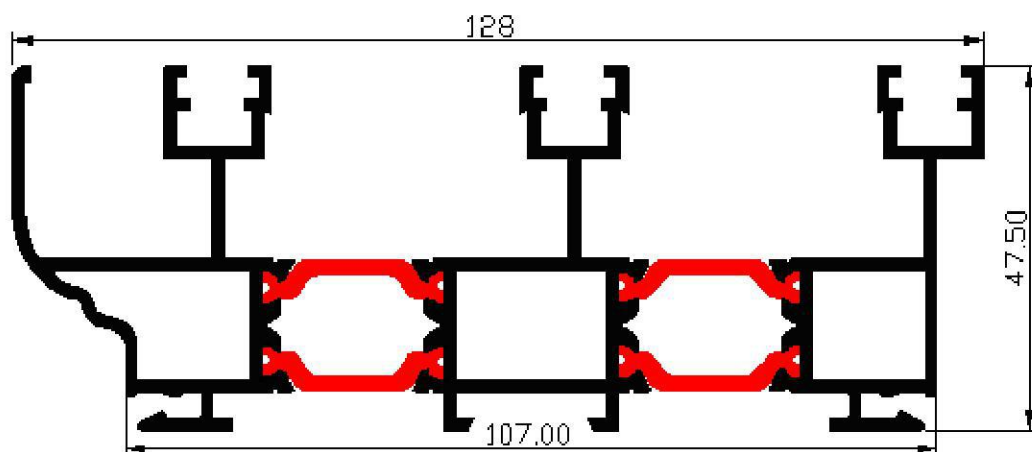

2120

DORMANT COULISSANT 3 VANTAUX COUVRE-JOINT INTÉGRÉ

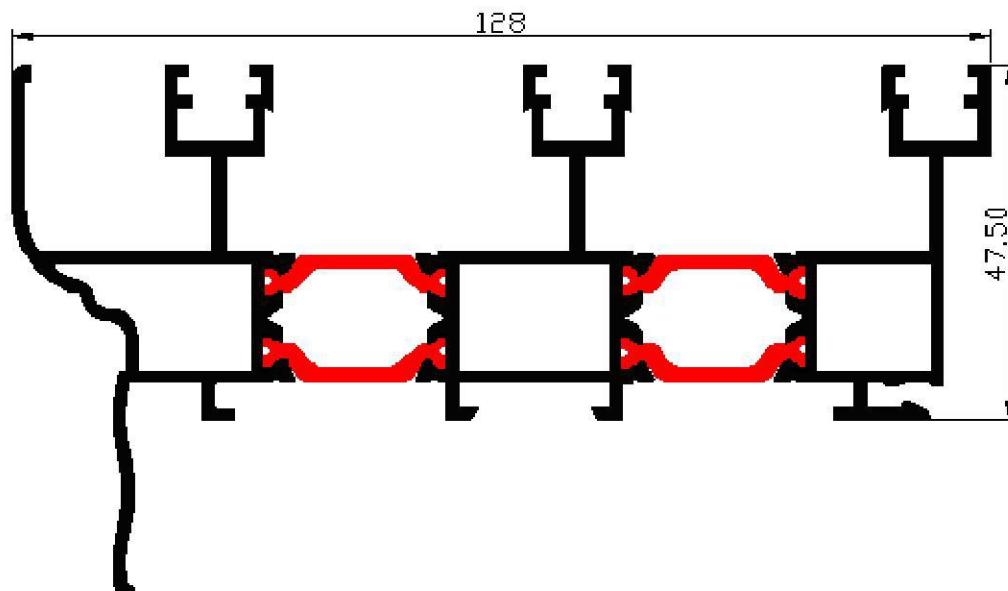

Alu Design System

2200

DORMANT COULISSANT 4 RAILS - PLAT

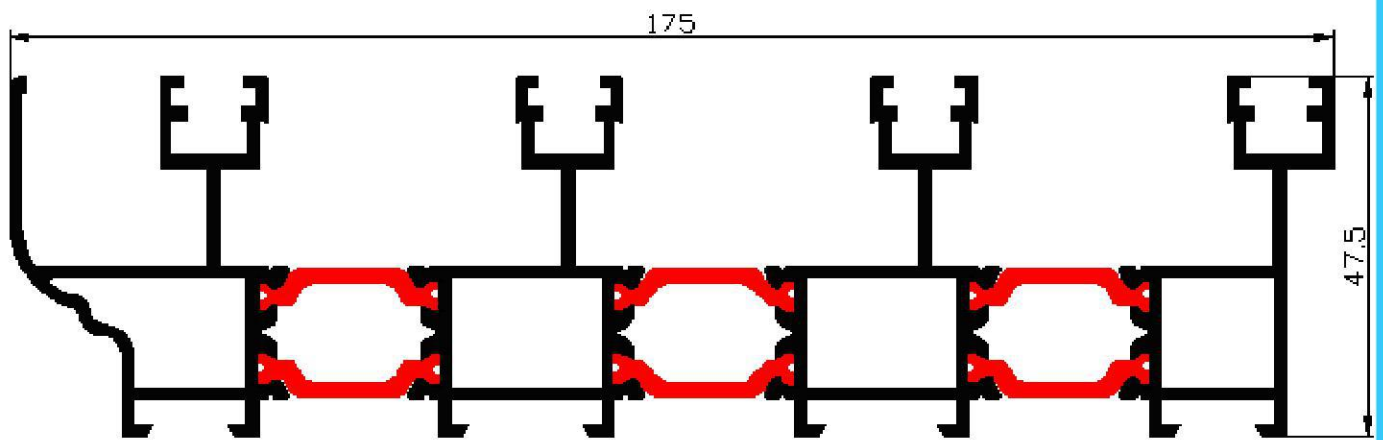

2210

DORMANT COULISSANT 4 RAILS DOUBLE CLIPS

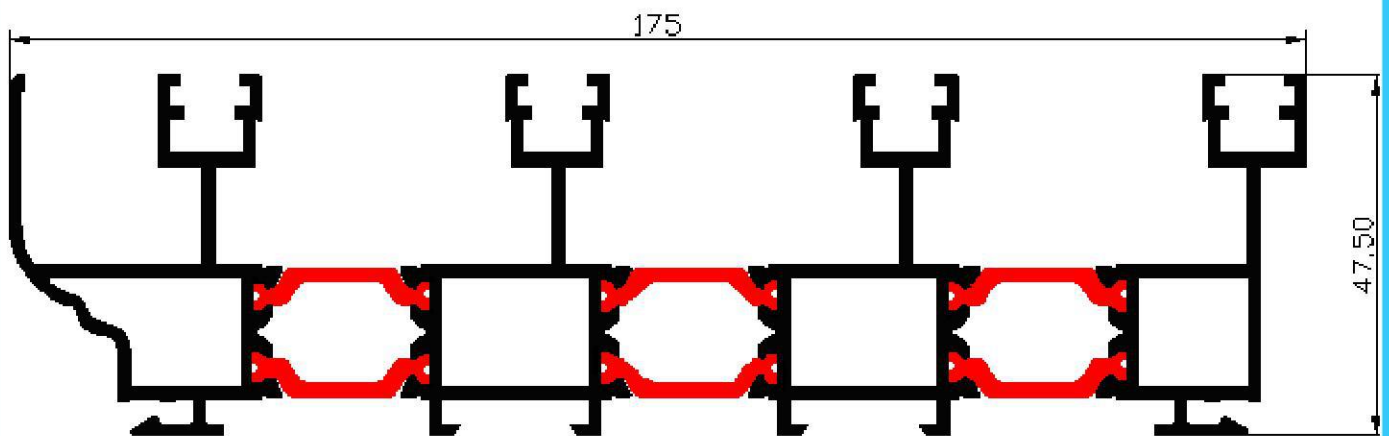

2220

DORMANT COULISSANT 4 RAILS COUVRE-JOINT INTÉGRÉ

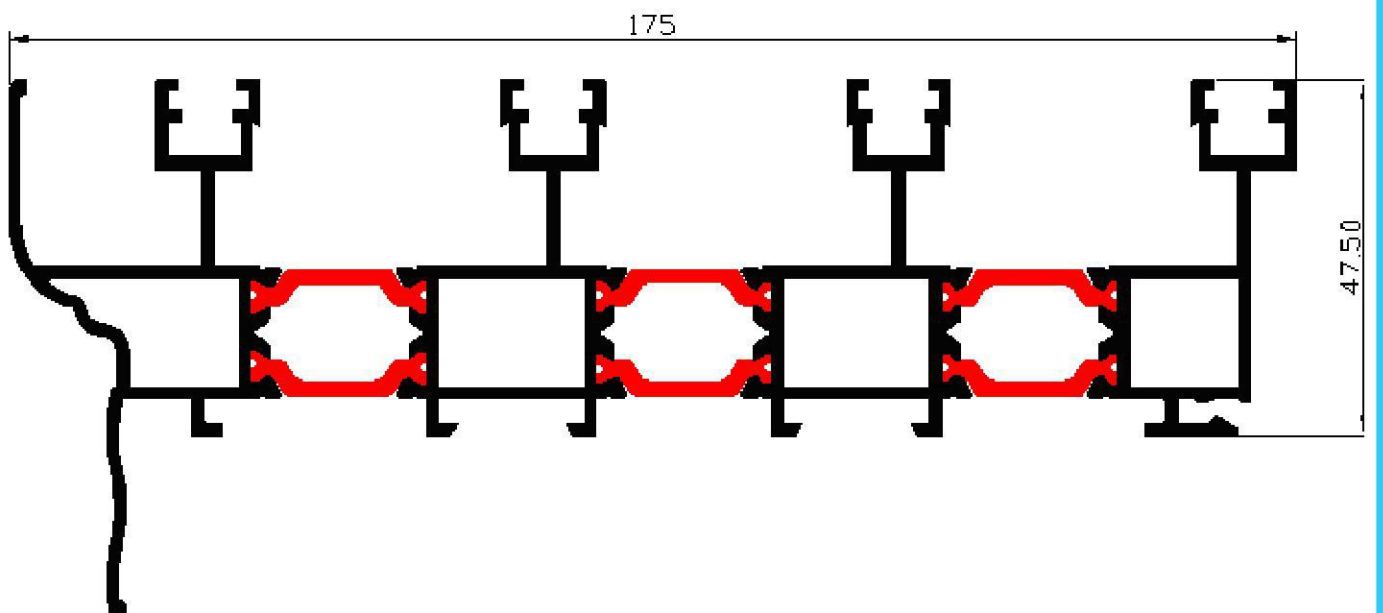

Alu Design System

2300

DORMANT COULISSANT 1 RAIL GALANDAGE

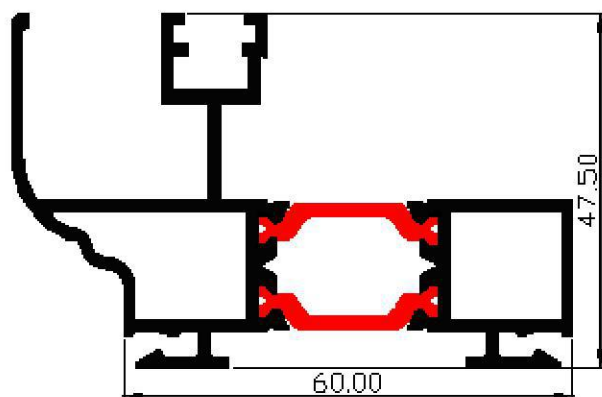

2310

DORMANT COULISSANT 2 RAILS GALANDAGE

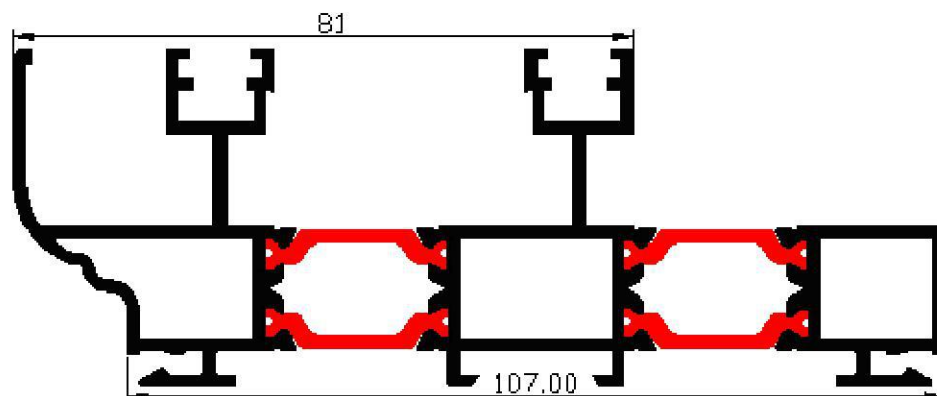

2320

DORMANT COULISSANT 3 RAILS GALANDAGE

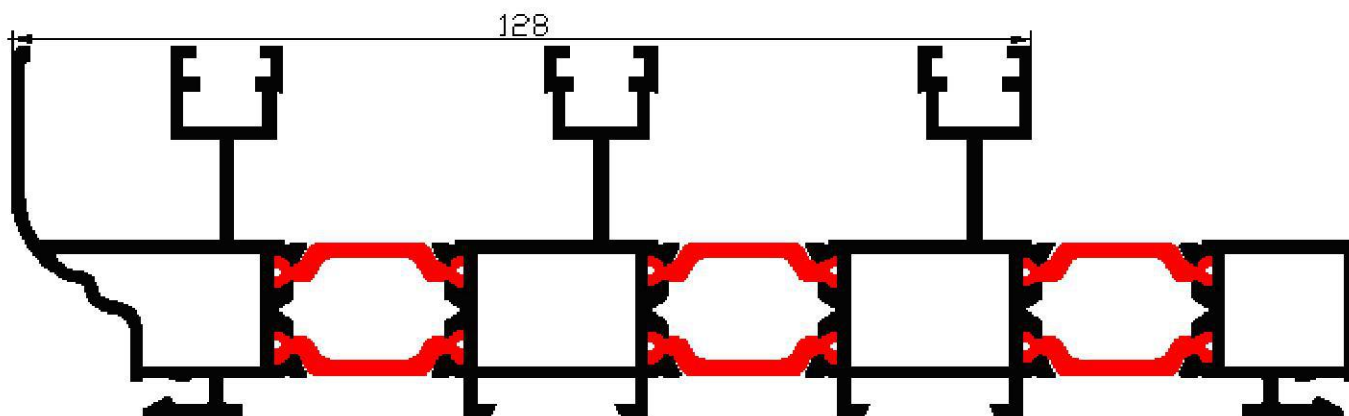

Alu Design System

2400

MONTANT SERRURE
COULISSANT

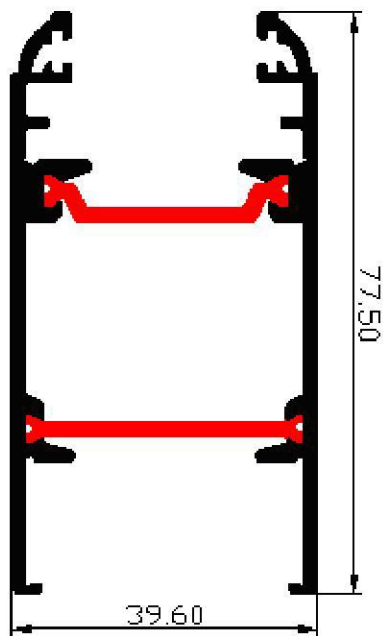

2410

MONTANT SERRURE
COULISSANT

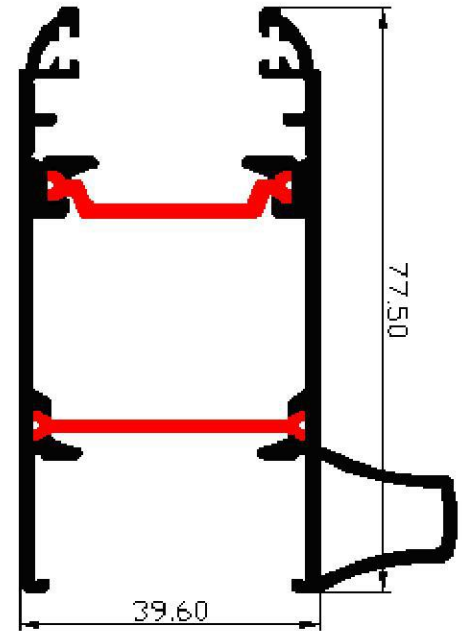

2420

MONTANT SERRURE COULISSANT
DOUBLE RENFORTS

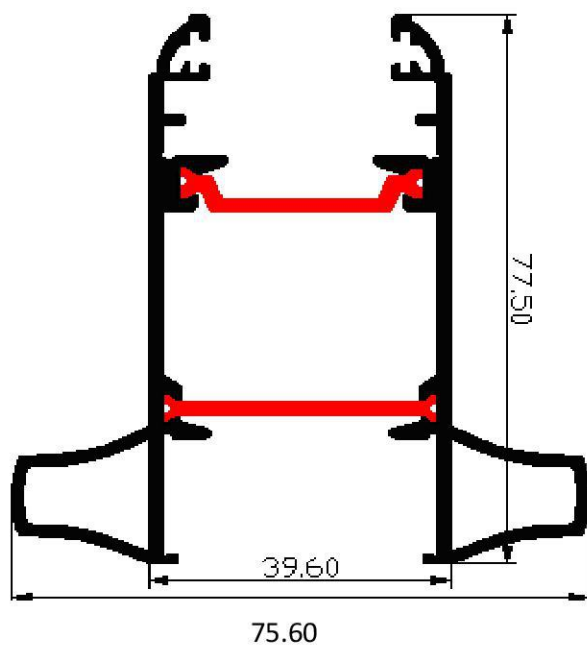

Alu Design System

2500

CHICANE SIMPLE

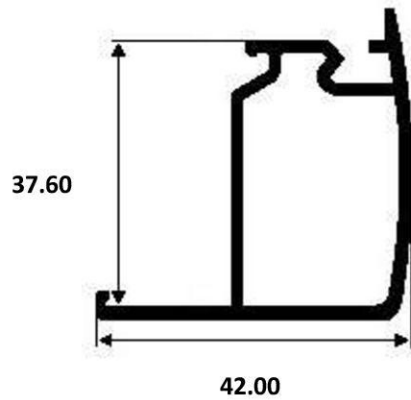

2510

CHICANE SIMPLE RENFORCÉE

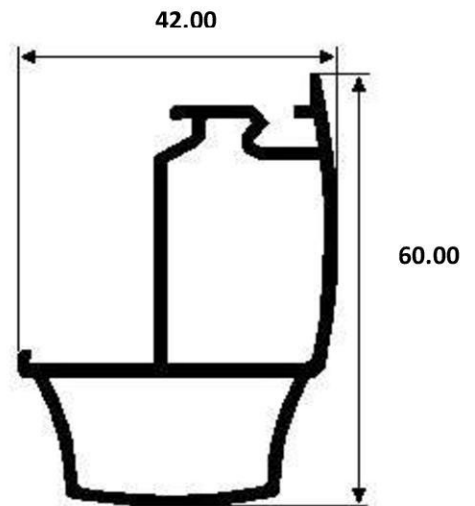

2520

CHICANE RENFORCÉE

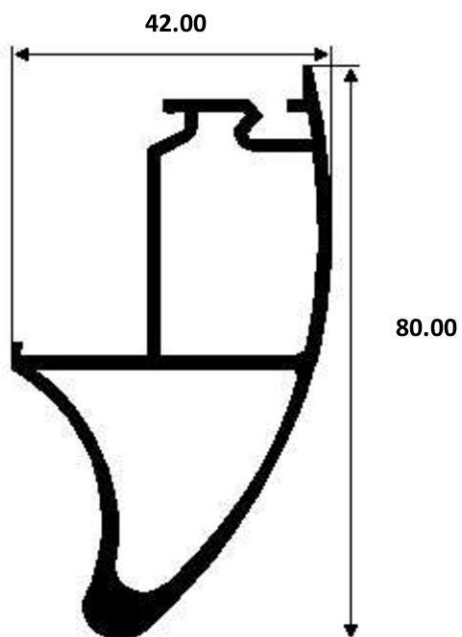

Alu Design System

2530

TRAVERSE COULISSANT

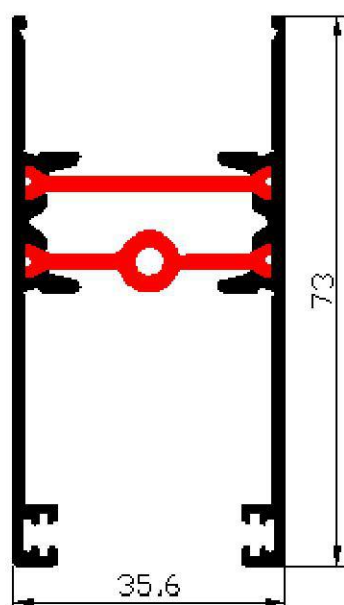

2540

TRAVERSE INTERMÉDIAIRE COULISSANT

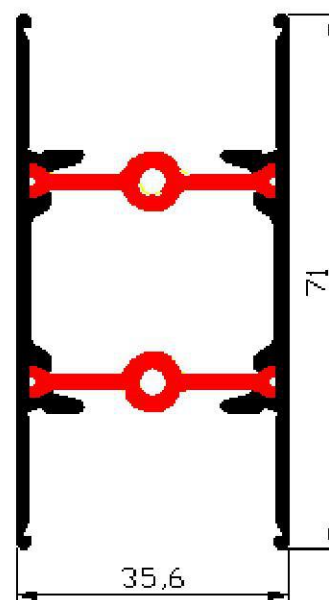

2600

EXTENSION INTERMÉDIAIRE GALANDAGE

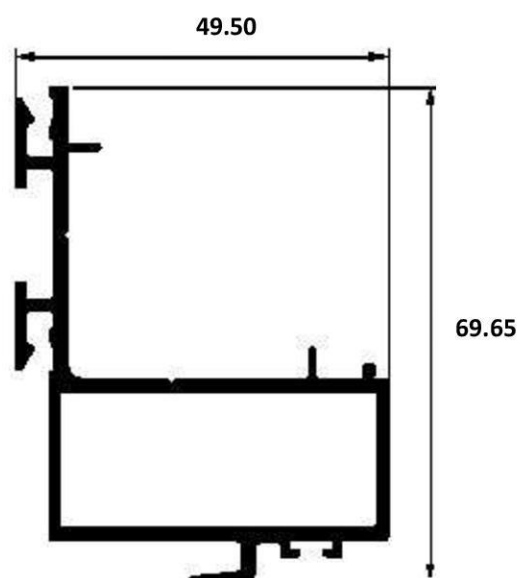

2610

ÉTANCHÉITÉ EXTÉRIEUR GALANDAGE

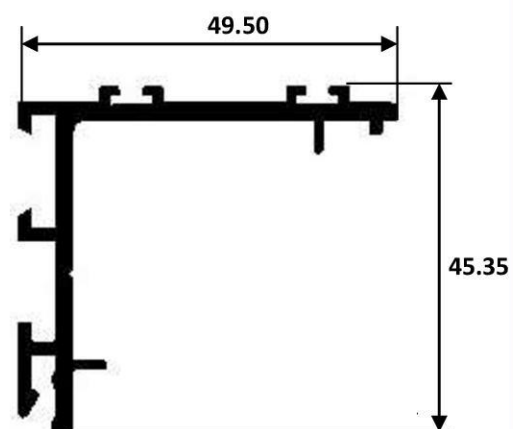

Alu Design System

2620

CAPOT EXTÉRIEUR
GALANDAGE

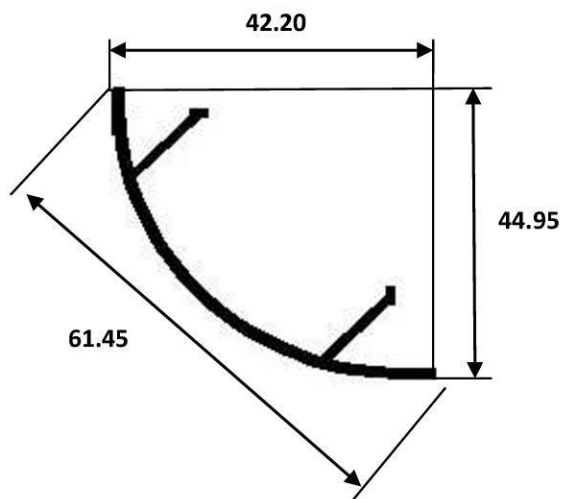

2630

PROFIL COMPLÉMENTAIRE
GALANDAGE INTÉRIEUR

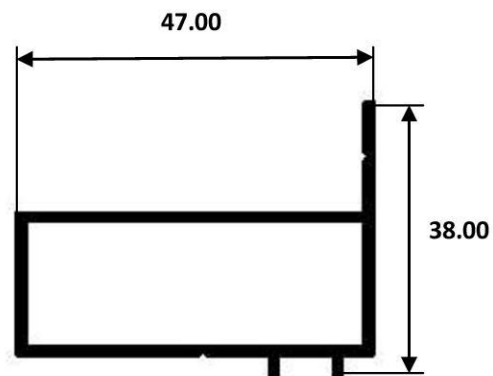

2640

PROFIL INTERMÉDIAIRE
GALANDAGE

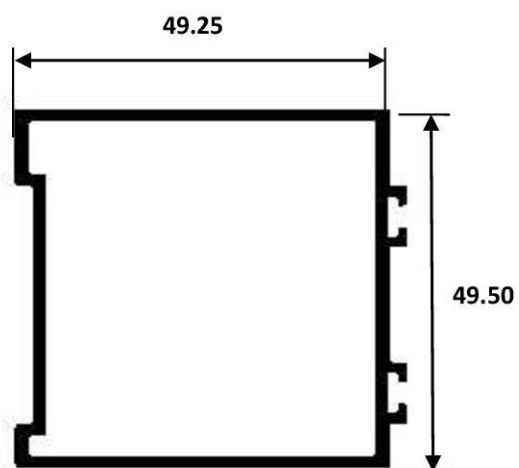

2650

JONCTION 4 VANTAUX
COULISSANT

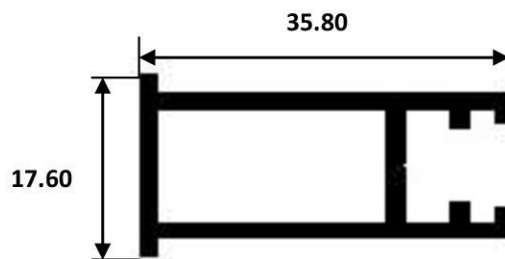

Alu Design System

2660

RAIL COULISSANT

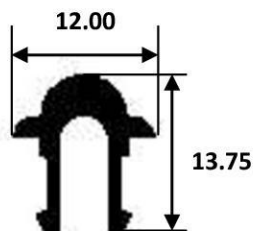

2670

CORNIÈRE HABILLAGE

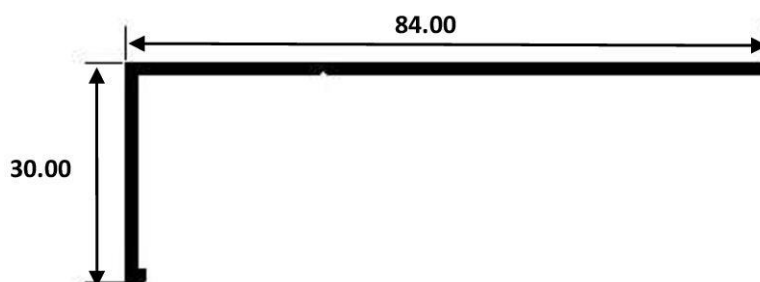

2720

PVC

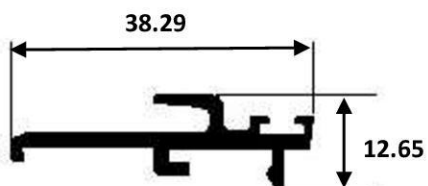

2730

PVC

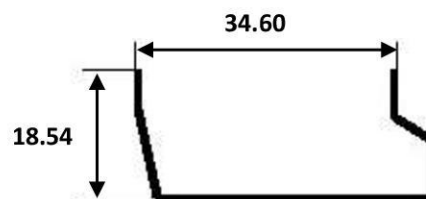

Alu Design System

2000-fr

SÉRIE FROIDE
DORMANT COULISSANT PLAT

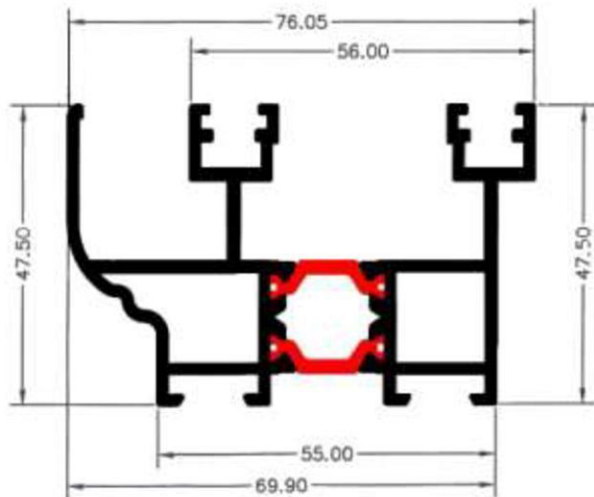

2010-fr

SÉRIE FROIDE
DORMANT COULISSANT DOUBLE CLIPS

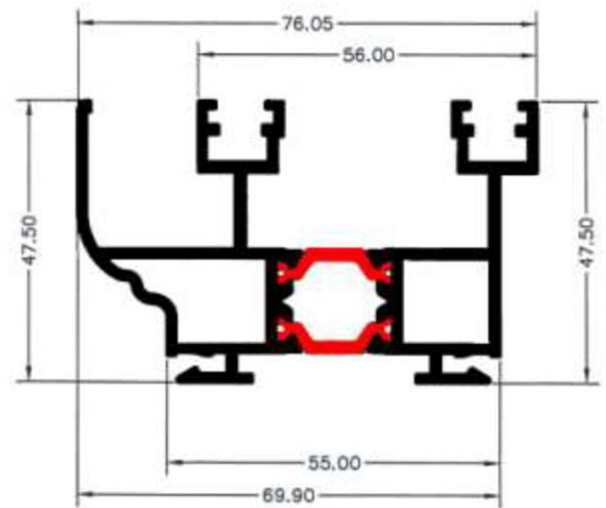

2100-fr

SÉRIE FROIDE
DORMANT COULISSANT 3 VANTAUX

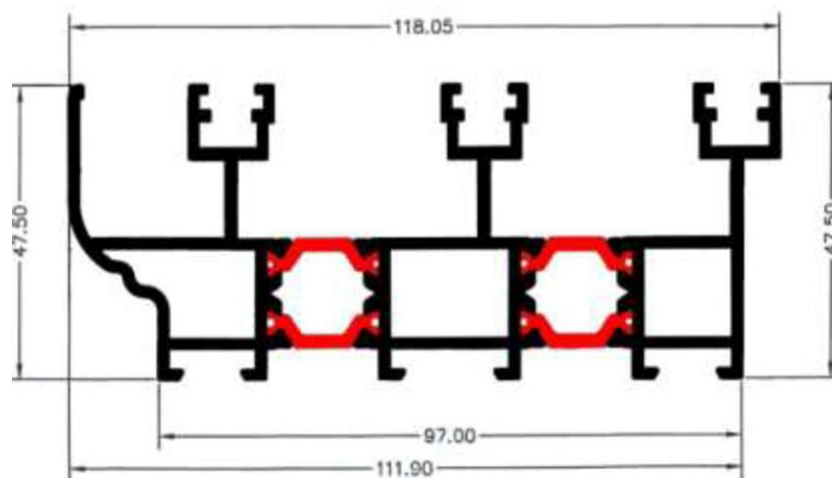

Alu Design System

2110-fr

SÉRIE FROIDE
DORMANT COULISSANT 3 VANTAUX DOUBLE CLIPS

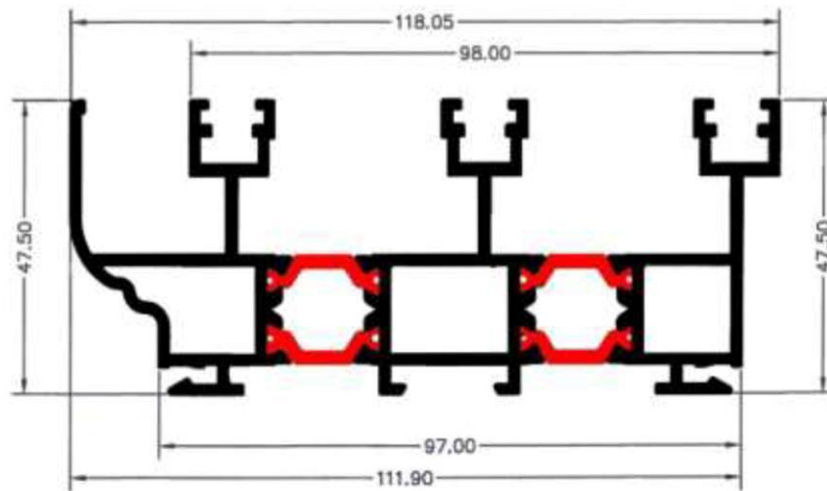

2200-fr

SÉRIE FROIDE
DORMANT COULISSANT 4 RAILS

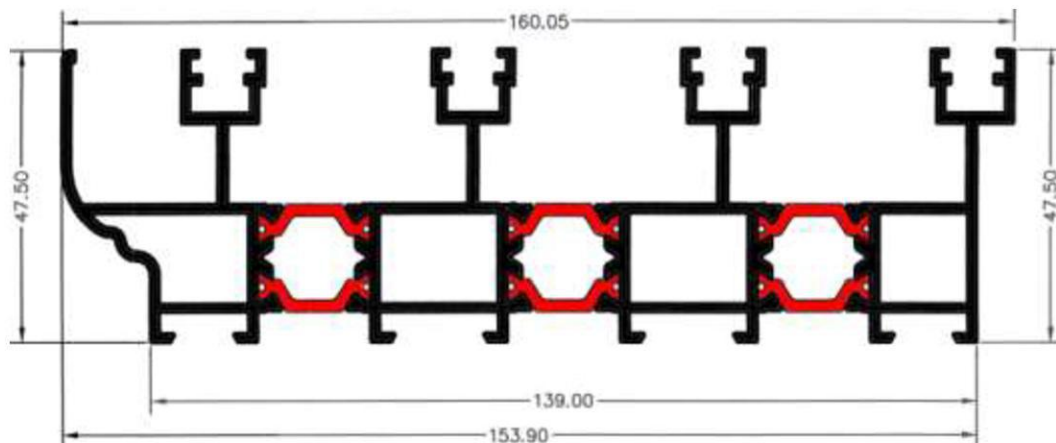

2210-fr

SÉRIE FROIDE
DORMANT COULISSANT 4 RAILS DOUBLE CLIPS

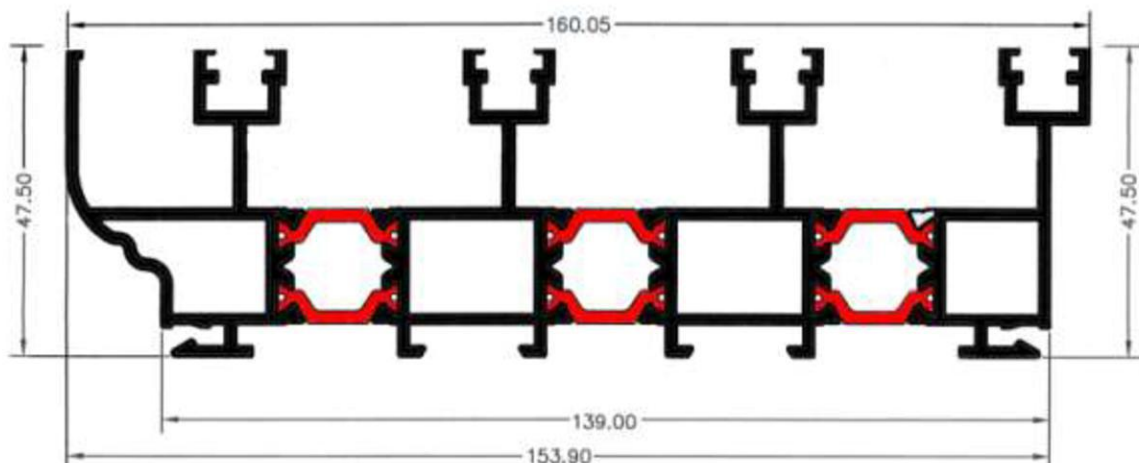

Alu Design System

2400-fr

SÉRIE FROIDE
MONTANT SERRURE COULISSANT

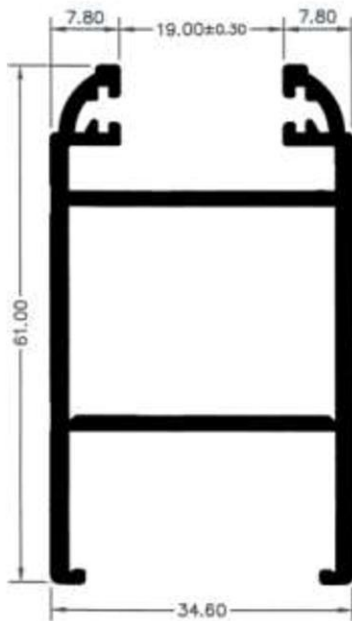

2410-fr

SÉRIE FROIDE MONTANT SERRURE
RENFORCÉ COULISSANT

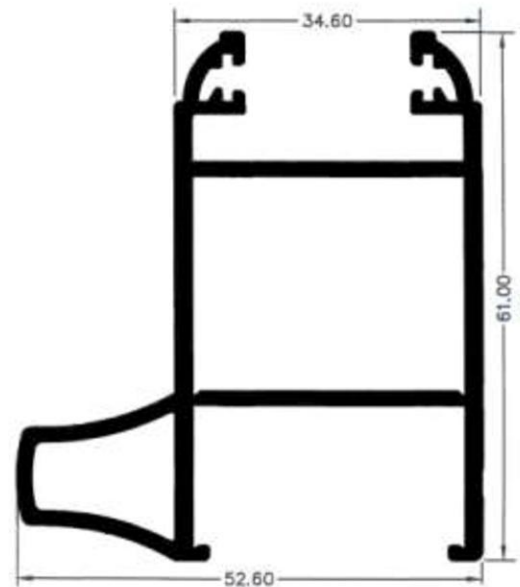

2500-fr

SÉRIE FROIDE
CHICANE SIMPLE

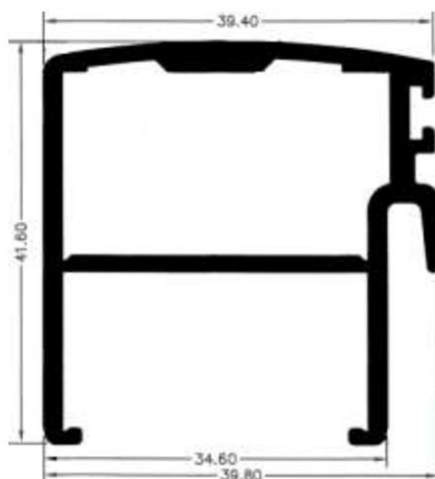

2520-fr

SÉRIE FROIDE
CHICANE SIMPLE RENFORCÉE

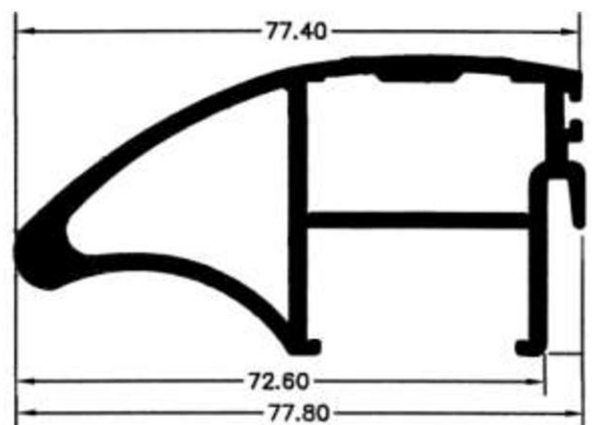







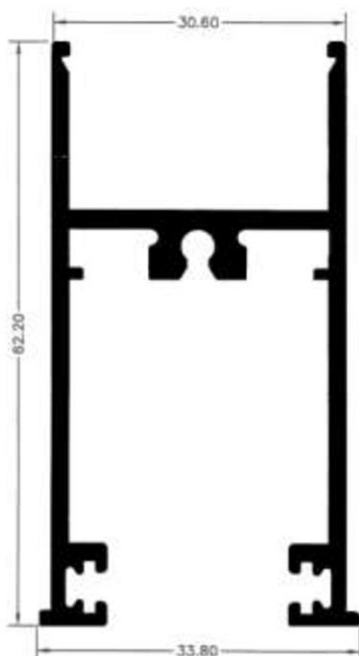

Alu Design System

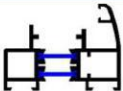
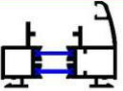
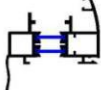
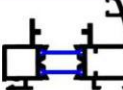
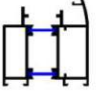
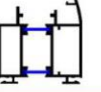
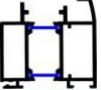
2530-fr

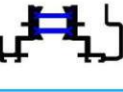
SÉRIE FROIDE
TRAVERSE COULISSANT



Série 3000 - Porte d'entrée

SILHOUETTE	RÉFÉRENCE ADS	RÉFÉRENCE TOLEDO	DÉSIGNATION	POIDS	PERIMÈTRE
	3000	34017	Petit dormant plat	1,288	0,366
	3010	34018	Petit dormant porte d'entrée double clips	1,317	0,373
	3020	34019	Petit dormant porte d'entrée couvre-joint intégré	1,396	0,418
	3040	34104	Petit dormant Clip Intérieur - Plat Extérieur	1,303	0,370
	3100	34020	Dormant porte d'entrée plat	1,735	0,412
	3110	34021	Dormant porte d'entrée double clips	1,764	0,419
	3140	34105	Dormant Clip Intérieur - Plat Extérieur	1,750	0,416
	3200	34026	Ouvrant porte d'entrée en Z	1,758	0,457
	3210	34027	Ouvrant porte d'entrée en T	1,758	0,458
	3300	34024	Porte brosse	0,652	0,282
	3400	47091	Seuil porte d'entrée 50mm	0,385	0,172
	3500	34068	Seuil handicapé 20mm	0,586	0,220
	3600	47053	Support seuil	1,691	0,124
	3700	34029	Traverse porte d'entrée 72mm	1,143	0,388
	3710	34030	Traverse porte d'entrée 84mm	1,357	0,413

suite... Série 3000

SILHOUETTE	RÉFÉRENCE ADS	RÉFÉRENCE TOLEDO	DÉSIGNATION	POIDS	PERIMÈTRE
	3720	34028	Traverse porte d'entrée 104mm	1,702	0,453
	3730	34060	Traverse porte d'entrée 144mm	2,393	0,528

Série Froide

3000 - Porte d'entrée

SILHOUETTE	RÉFÉRENCE ADS	RÉFÉRENCE TOLEDO	DÉSIGNATION	POIDS	PERIMÈTRE
	3100FR	47142	Série Froide Dormant plat porte d'entrée	1,381	0,381
	3110FR	47143	Série Froide Dormant porte d'entrée double clips	1,409	0,388
	3200FR	47144	Série Froide Ouvrant porte d'entrée en Z	1,495	0,439
	3210FR	47145	Série Froide Ouvrant porte d'entrée en T	1,495	0,439

Alu Design System

3000

PETIT DORMANT PLAT

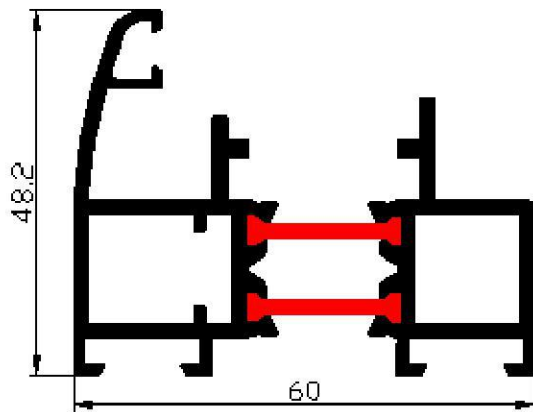

3010

PETIT DORMANT PORTE D'ENTRÉE DOUBLE CLIPS

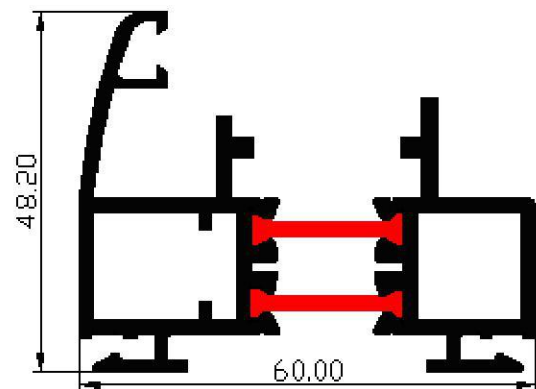

3020

PETIT DORMANT PORTE D'ENTRÉE COUVRE-JOINT INTÉGRÉ

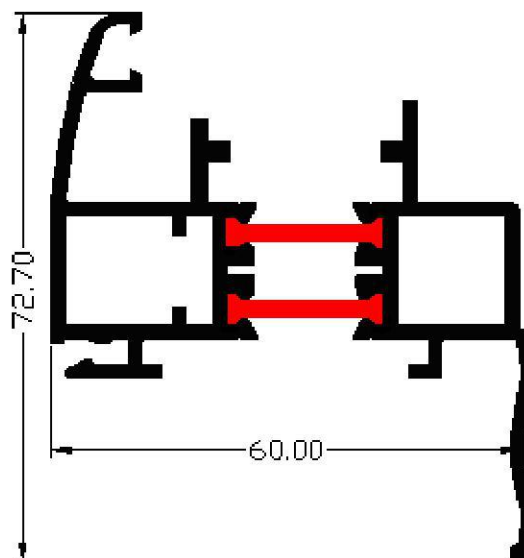

3040

PETIT DORMANT PORTE D'ENTRÉE Clip Intérieur - Plat Extérieur

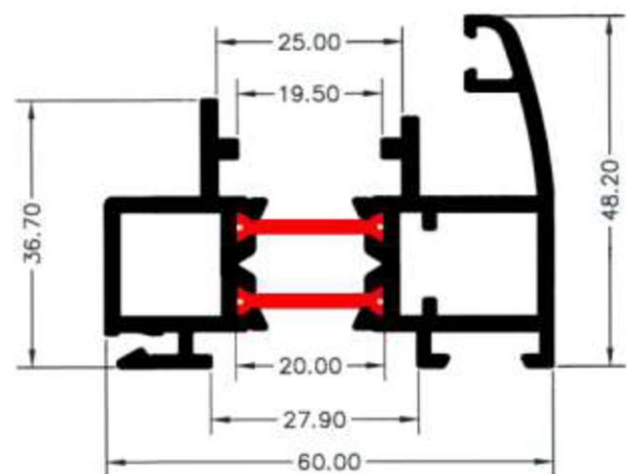

Alu Design System

3100

DORMANT PORTE d'ENTRÉE
PLAT

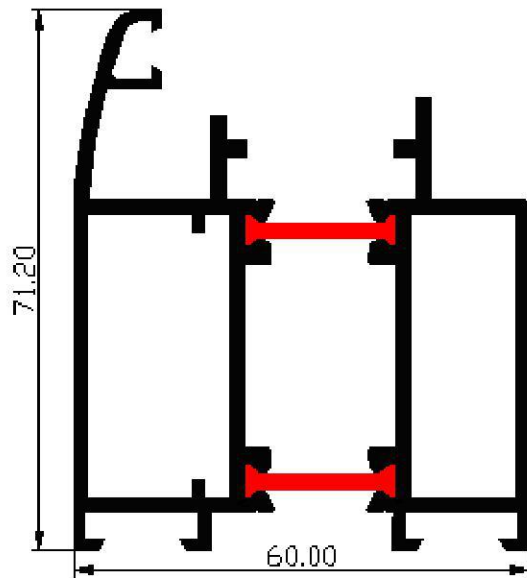

3110

DORMANT PORTE D'ENTRÉE
DOUBLE CLIPS

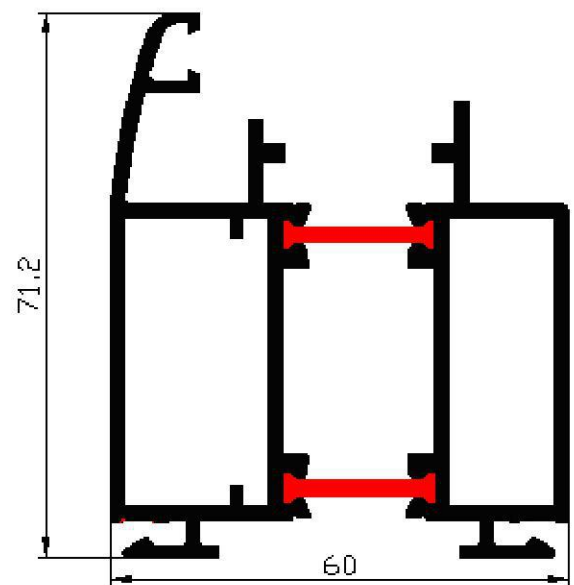

3140

DORMANT PORTE d'ENTRÉE Clip Intérieur – Plat Extérieur

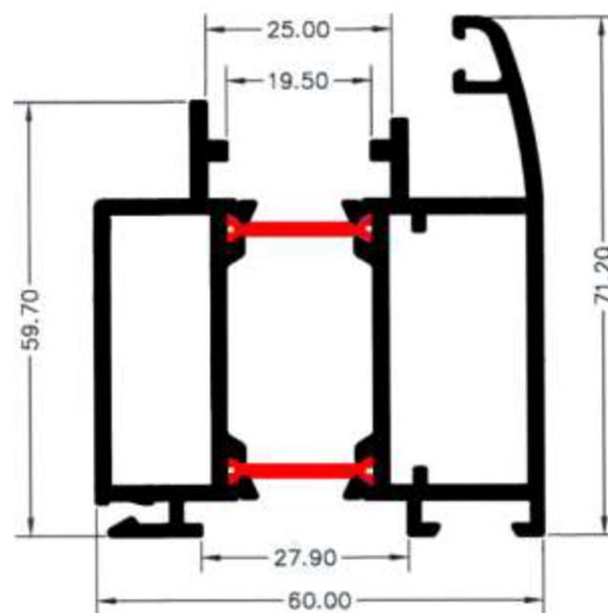

Alu Design System

3200

OUVRANT PORTE D'ENTRÉE EN Z

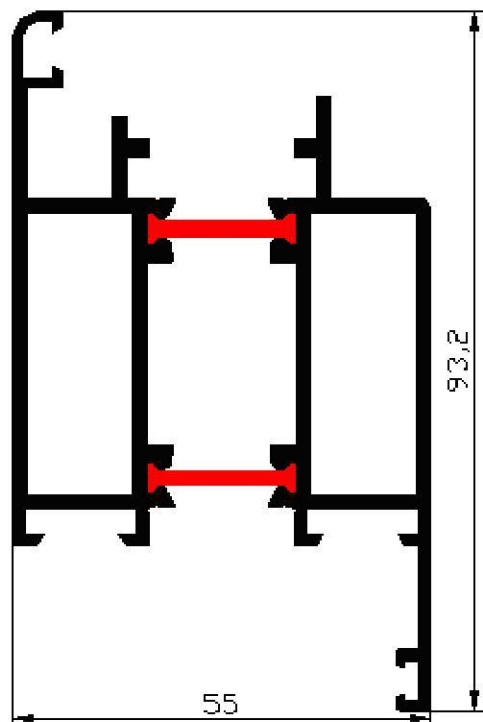

3210

OUVRANT PORTE D'ENTRÉE EN T

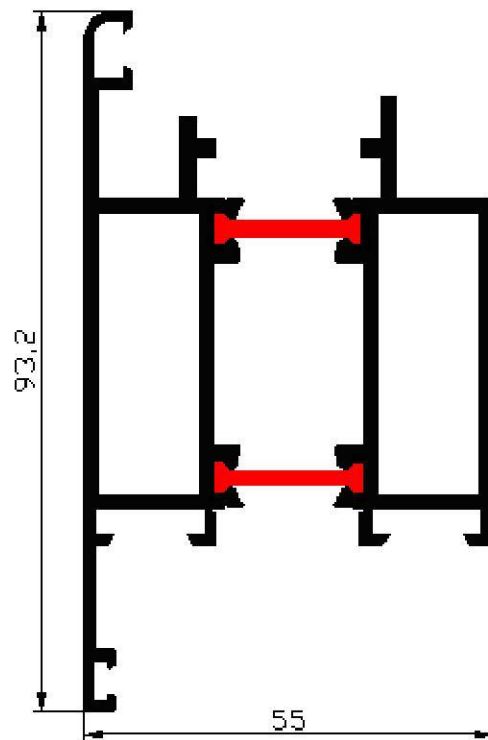

Alu Design System

3300

PORTE BROSSE

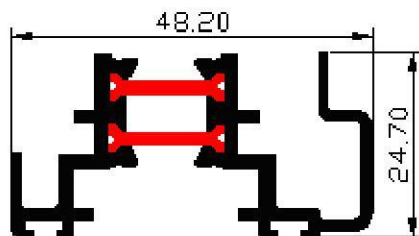

3400

SEUIL PORTE D'ENTRÉE
50mm

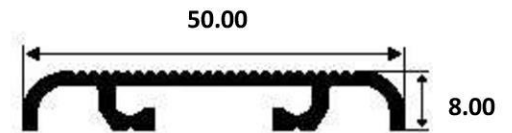

3500

SEUIL HANDICAPÉ
20mm

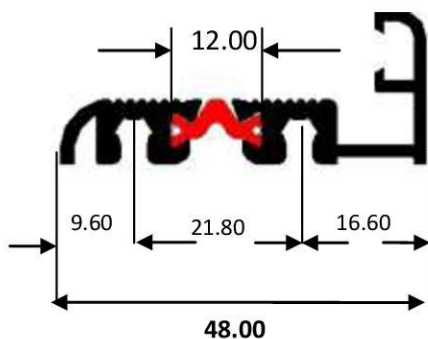

3600

SUPPORT SEUIL



Alu Design System

3700

TRAVERSE PORTE D'ENTRÉE
72mm

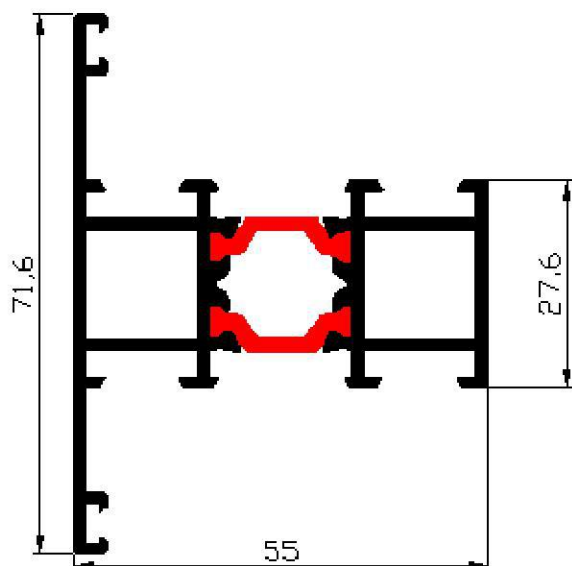

3710

TRAVERSE PORTE D'ENTRÉE
84mm

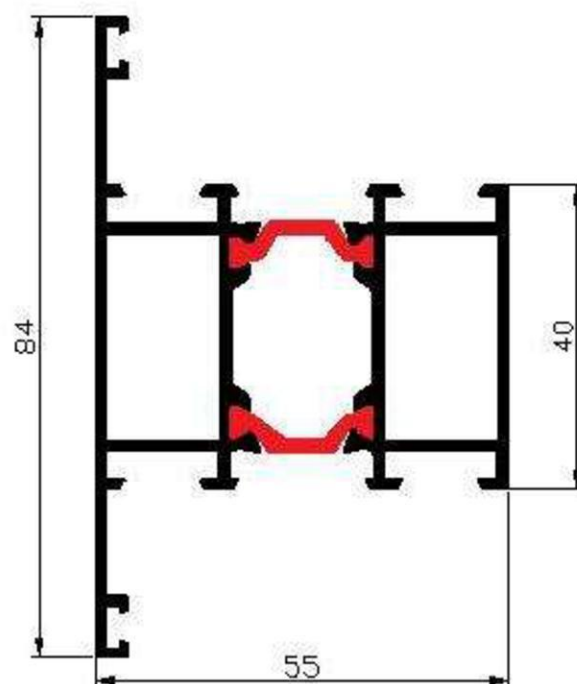

3720

TRAVERSE PORTE D'ENTRÉE 104mm

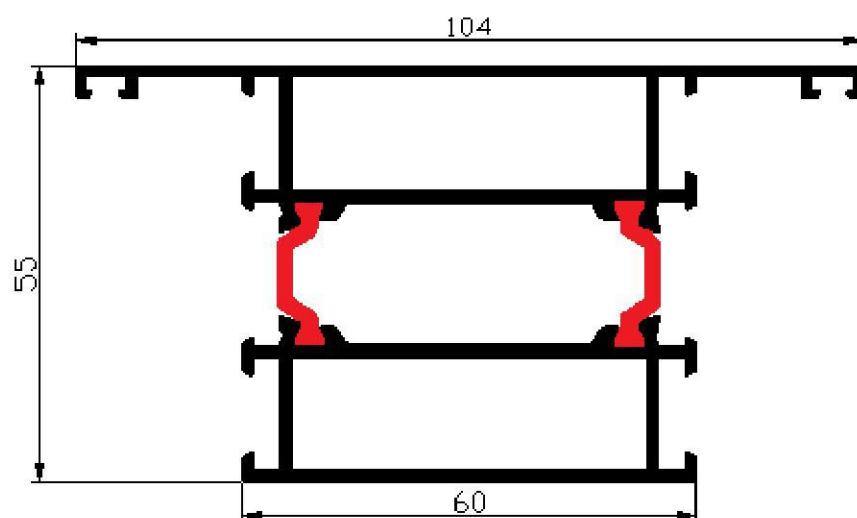

Alu Design System

3730

TRAVERSE PORTE D'ENTRÉE 144mm

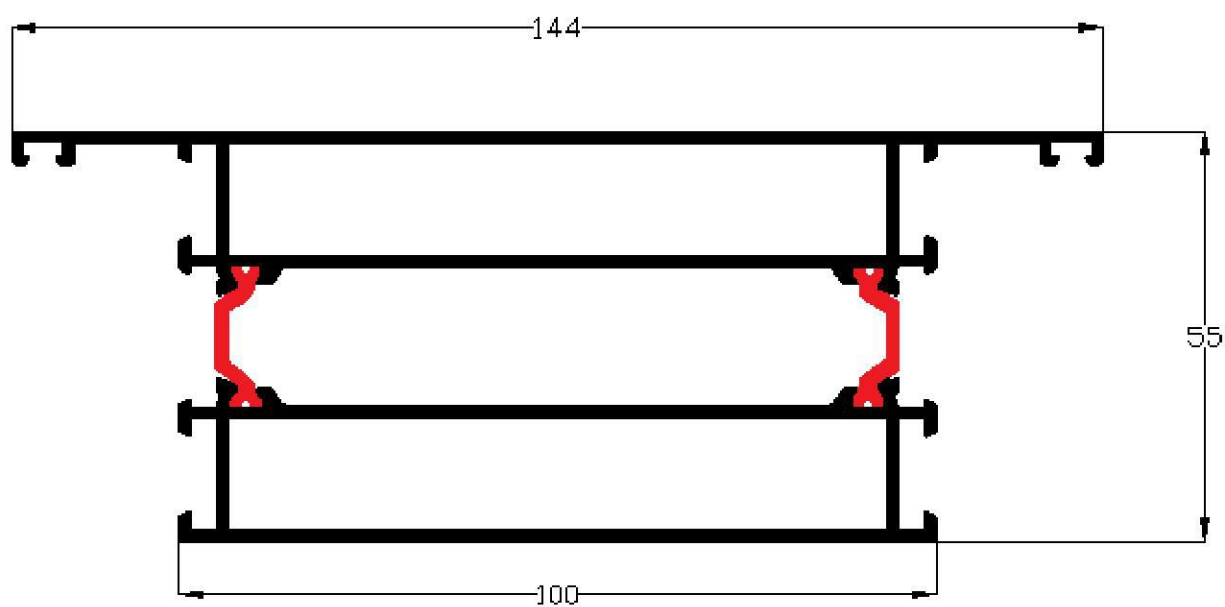

Alu Design System

3100-fr

**DORMANT PLAT PORTE
D'ENTRÉE - Série froide**

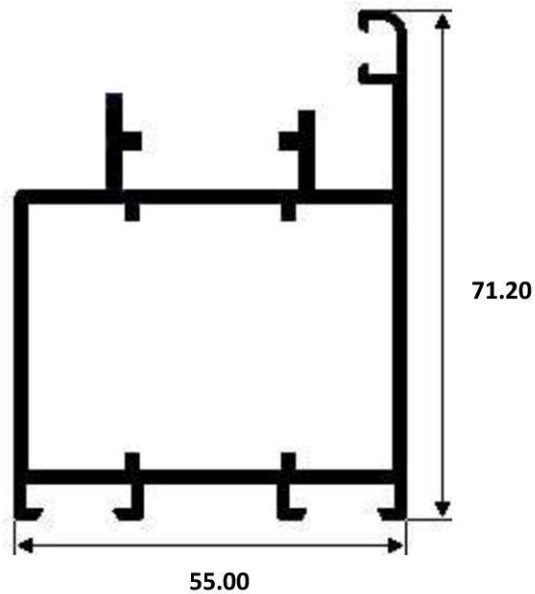

3110-fr

**DORMANT PORTE D'ENTRÉE
DOUBLE CLIPS - Série froide**

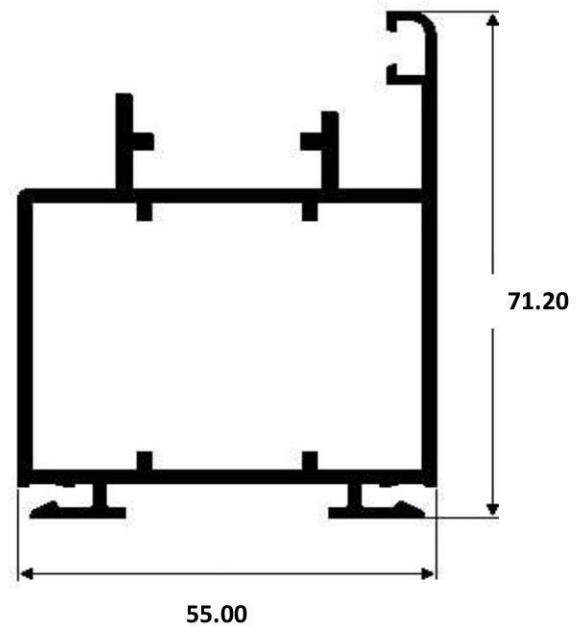

3200-fr

**OUVRANT PORTE D'ENTRÉE
en Z - Série Froide**

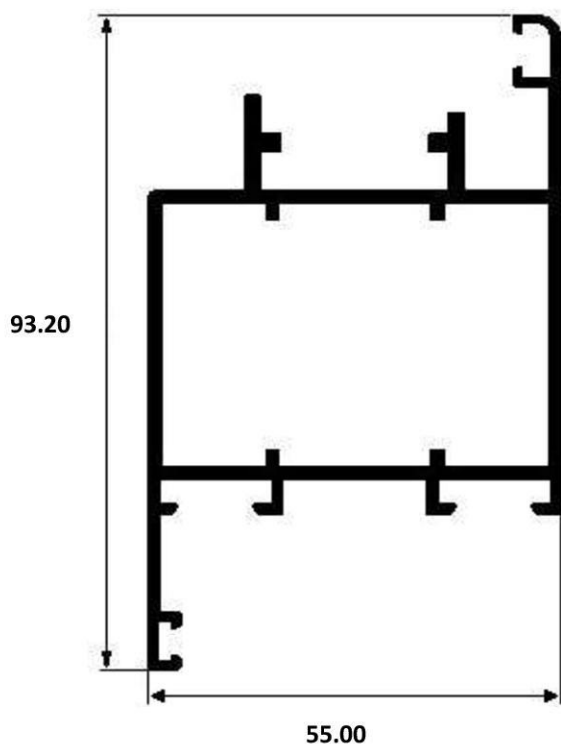

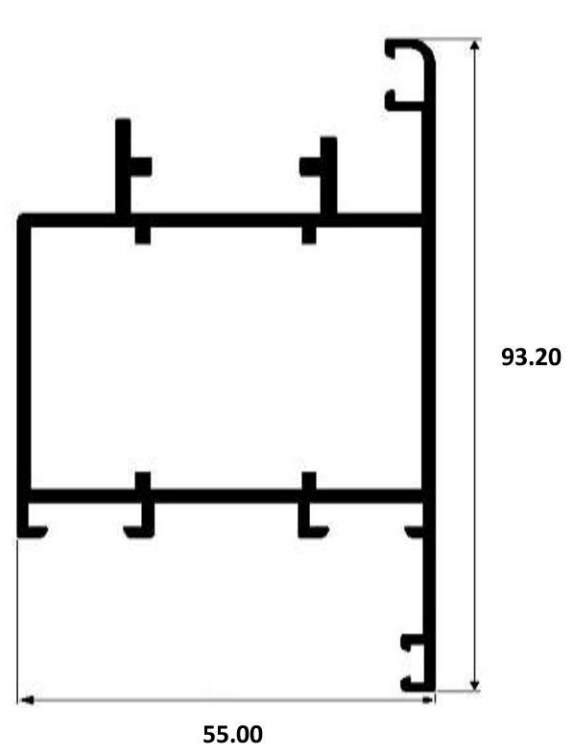

3210-fr

**OUVRANT PORTE D'ENTRÉE
en T - Série Froide**

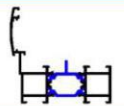
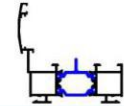
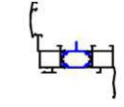
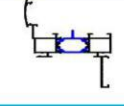
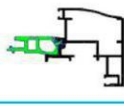
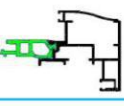
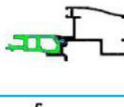
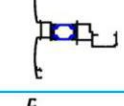
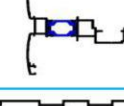
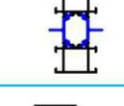
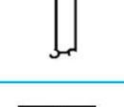

Série 4000 - Ouvrant caché

SILHOUETTE	RÉFÉRENCE ADS	RÉFÉRENCE TOLEDO	DÉSIGNATION	POIDS	PERIMÈTRE
	4000	34075	Dormant ouvrant caché plat	1,174	0,421
	4010	34074	Dormant ouvrant caché double clips	1,199	0,426
	4020	34084	Dormant ouvrant caché couvre-joint intégré	1,278	0,471
	4030	34085	Dormant ouvrant caché rénovation	1,401	0,514
	4100	34069	Ouvrant caché droit vitrage 24mm	1,018	0,351
	4200	34070	Ouvrant caché droit vitrage 28mm	1,031	0,373
	4210	34071	Ouvrant caché gauche vitrage 28mm	0,733	0,286
	4300	34073	Meneau ouvrant caché	1,097	0,422
	4300-70	34072	Meneau ouvrant caché - 70 mm	1,097	0,429
	4400	34034	Traverse réhausse ouvrant caché	1,417	0,541
	4520	47134	Parclose ouvrant caché 24mm	0,409	0,156
	4530	47155	Couvre battement fenêtre	0,433	0,215

Alu Design System

4000

DORMANT OUVRANT CACHÉ PLAT

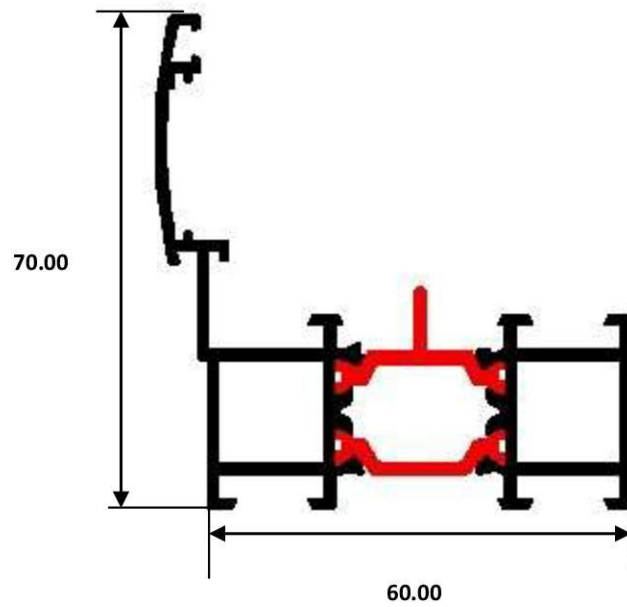

4010

DORMANT OUVRANT CACHÉ DOUBLE CLIPS

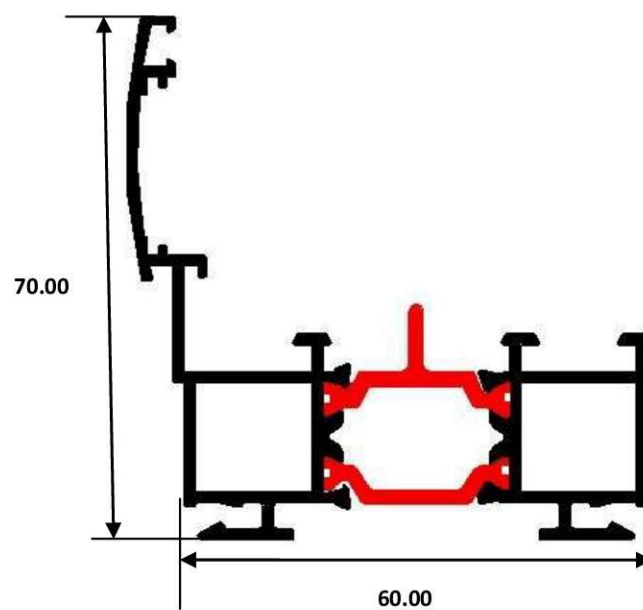

Alu Design System

4020

DORMANT OUVRANT CACHÉ COUVRE-JOINT INTEGRÉ

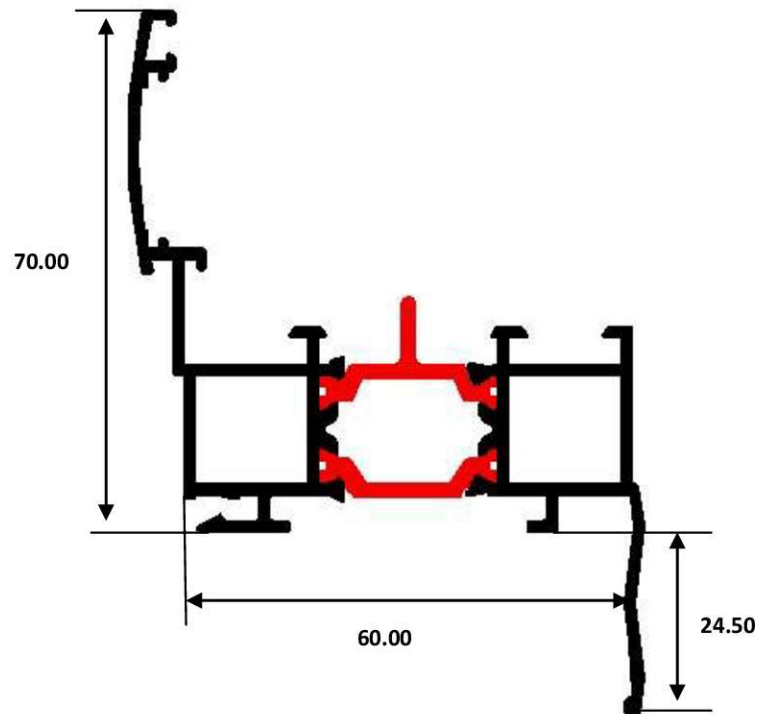

4030

DORMANT OUVRANT CACHÉ RÉNOVATION

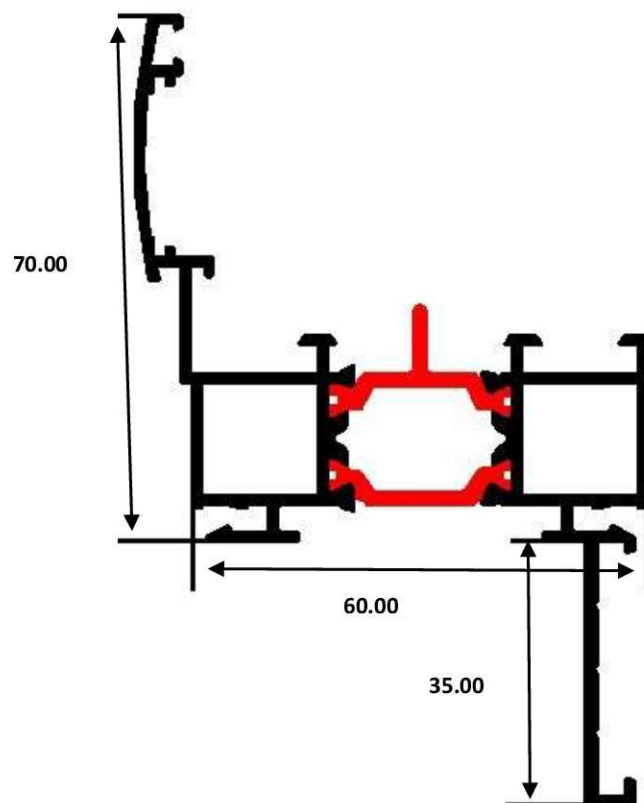

Alu Design System

4100

OUVRANT CACHÉ DROIT
VITRAGE 24mm

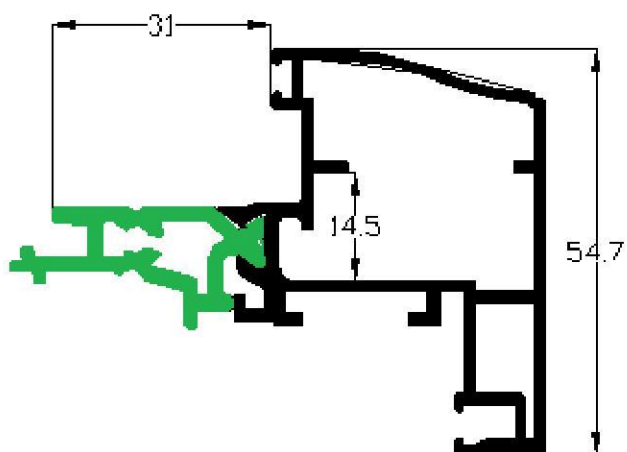

4200

OUVRANT CACHÉ DROIT
VITRAGE 28 mm

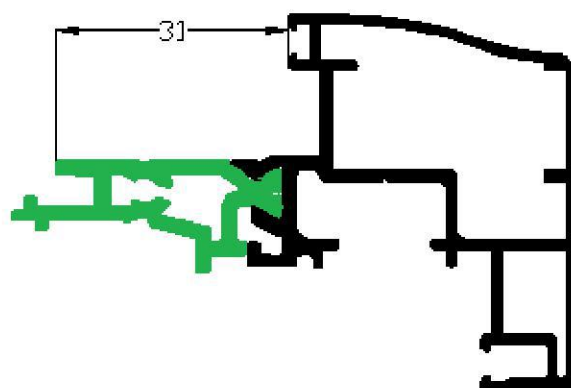

4210

OUVRANT CACHÉ GAUCHE
VITRAGE 24mm

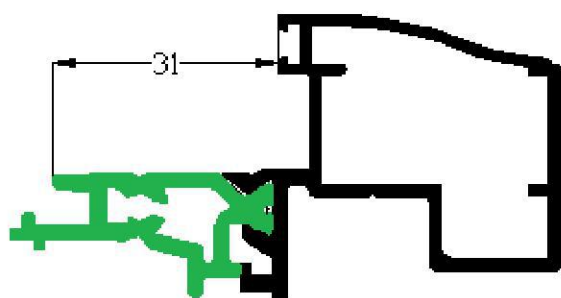

4300

MENEAU OUVRANT CACHÉ

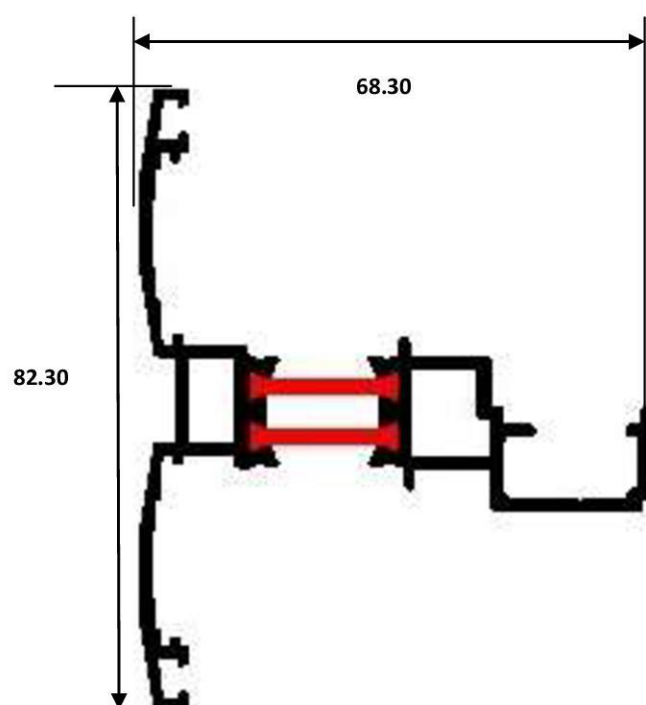

Alu Design System

4300-70

MENEAU OUVRANT
CACHÉ 70mm

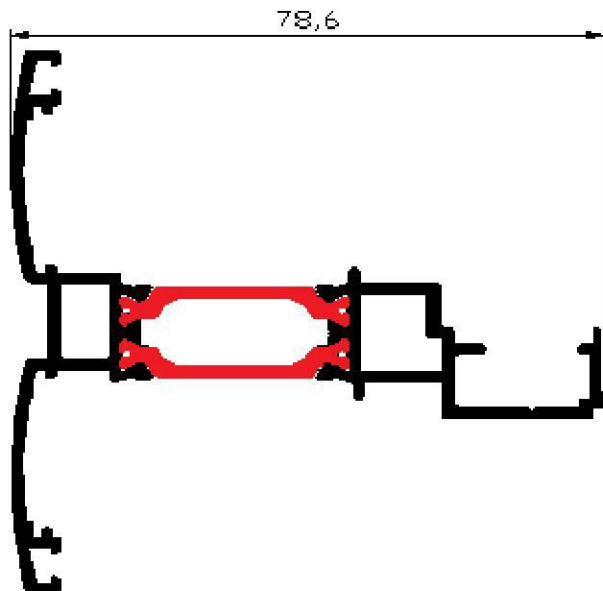

4400

TRAVERSE REHAUSSE
OUVRANT CACHÉ

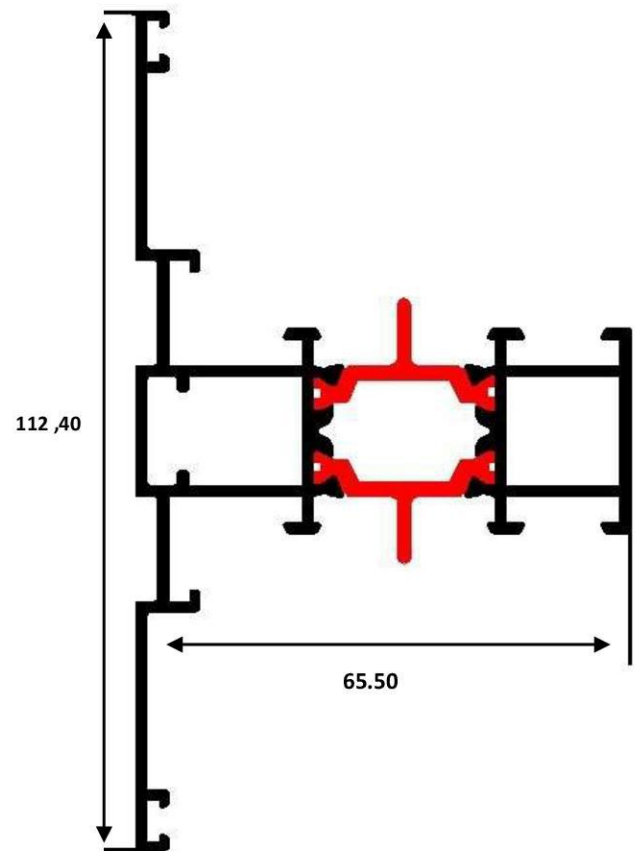

4520

PARCLOSE OUVRANT CACHÉ
24mm

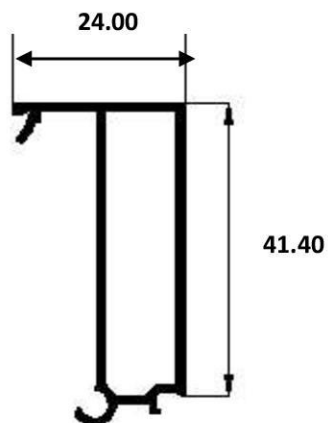



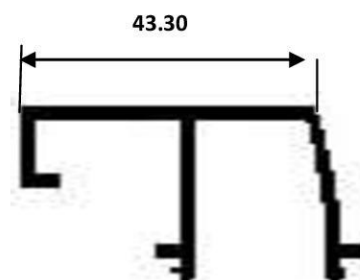

4530

COUVRE BATTEMENT FENÊTRE

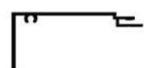

Série 5000 - Profils communs

SILHOUETTE	RÉFÉRENCE ADS	RÉFÉRENCE TOLEDO	DÉSIGNATION	POIDS	PERIMÈTRE
	5000	47033	Tapée isolation 100mm	0,466	0,215
	5010	47034	Tapée isolation 120mm	0,557	0,255
	5020	47035	Tapée isolation 140mm	0,649	0,295
	5030	47036	Tapée isolation 160mm	0,741	0,335
	5100	47070	Parclose 23mm	0,267	0,113
	5105	47117	parclose de 20mm	0,257	0,107
	5110	47071	Parclose 18mm	0,251	0,103
	5115	47118	Parclose de 16mm	0,244	0,096
	5120	47072	Parclose 12mm	0,236	0,094
	5130	47073	Parclose 8mm	0,225	0,090
	5150	47150	Parclose 18mm moulurée à clips	0,227	0,091
	5160	47089	Parclose 23 mm arrondie	0,287	0,105
	5170	47090	Parclose 23mm arrondie à clips	0,324	0,106
	5180	47146	Parclose arrondie 18mm à clips	0,280	0,095
	5190	47147	Parclose arrondie 12mm à clips	0,231	0,080
	5200	47046	Couvre-joint 30mm	0,187	0,092

Suite... Série 5000

SILHOUETTE	RÉFÉRENCE ADS	RÉFÉRENCE TOLEDO	DÉSIGNATION	POIDS	PERIMÈTRE
	5210	47047	Couvre-joint 50mm	0,282	0,139
	5220	47048	Couvre-joint 80mm	0,412	0,199
	5230	47056	Bavette 70mm	0,422	0,209
	5240	47057	Bavette 110mm	0,584	0,289
	5300	34065	H de liaison	0,778	0,293
	5400	34035	Raidisseur 40mm	2,118	0,408
	5410	34032	Réhausse 28mm	0,916	0,278
	5420	34033	Réhausse 40mm	1,130	0,303
	5430	34031	Réhausse 60mm	1,474	0,343
	5440	34079	Réhausse 100mm	2,166	0,423
	5500	34036	Raidisseur 60mm	2,719	0,478
	5600	34055	Angle variable gauche	1,066	0,346
	5610	34056	Angle variable droit	1,112	0,368
	5700	47058	Equerre 37mm	4,115	0,378
	5710	47037	Equerre 14mm	3,300	0,317
	5720	47049	Tenon	0,824	0,130

Suite... Série 5000

SILHOUETTE	RÉFÉRENCE ADS	RÉFÉRENCE TOLEDO	DÉSIGNATION	POIDS	PERIMÈTRE
	5730	47119	Équerre variable	0,838	0,213
	5740	47173	Équerre articulée à usiner	1,427	0,231
	5800	47151	Reconstitution de feuillure à visser	0,185	0,096
	5810	47152	Parclose 30mm	0,303	0,121
	5820	47153	Rejet d'eau à clipper	0,404	0,157

Alu Design System

5000

TAPÉE ISOLATION 100mm

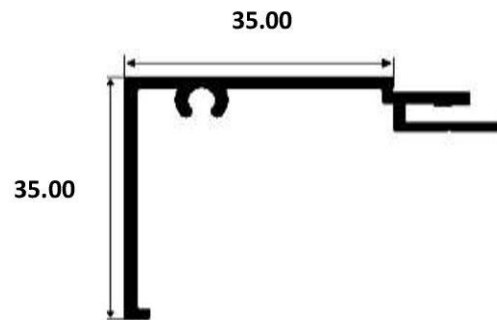

5010

TAPÉE ISOLATION 120mm

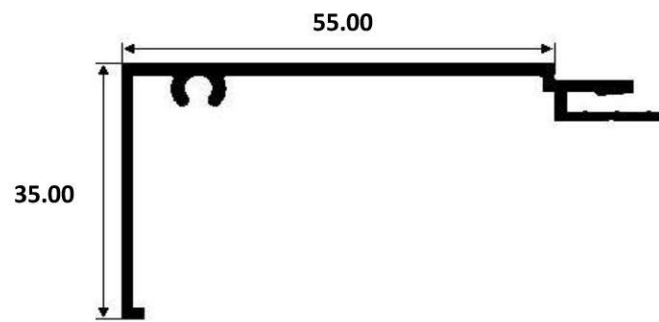

5020

TAPÉE ISOLATION 140mm

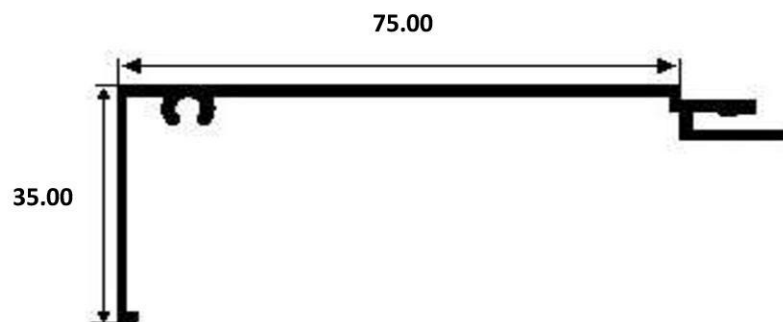

5030

TAPÉE ISOLATION 160mm

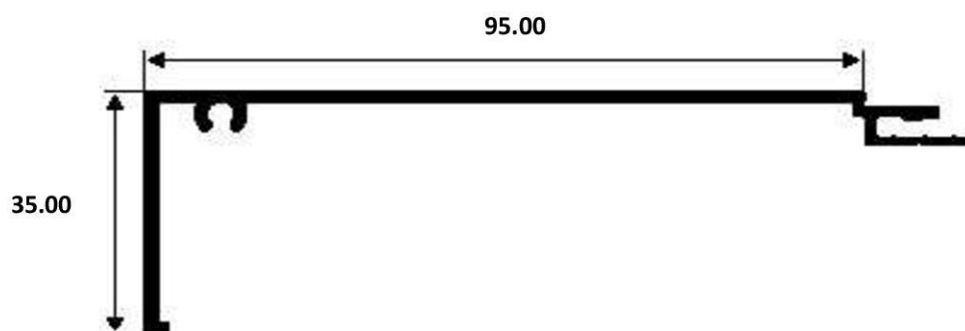

Alu Design System

5100

PARCLOSE 23mm

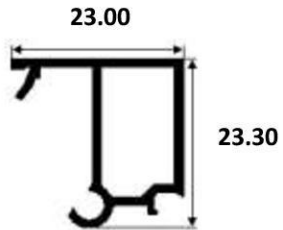

5105

PARCLOSE 20mm

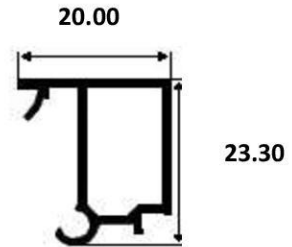

5110

PARCLOSE 18mm

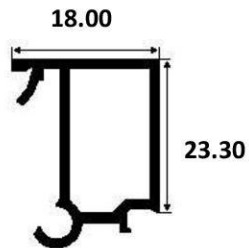

5115

PARCLOSE 16mm

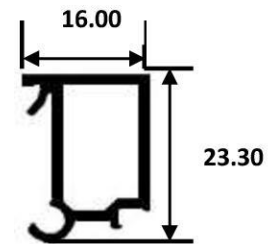

5120

PARCLOSE 12mm

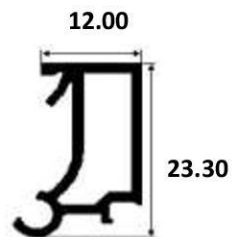

5130

PARCLOSE 8mm

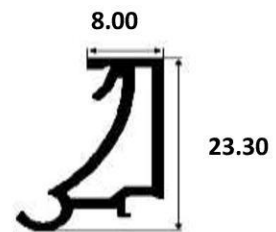

5140

PARCLOSE 18mm MOULURÉE

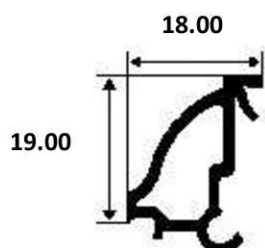

5150

PARCLOSE 18mm MOULURÉE Á CLIPS

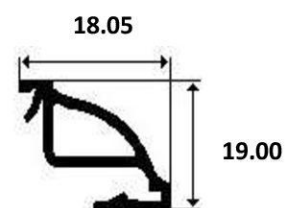

Spécimen à l'étude

Alu Design System

5160

PARCLOSE ARRONDIE
23mm

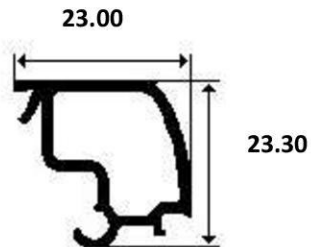

5170

PARCLOSE ARRONDIE Á
CLIP 23mm

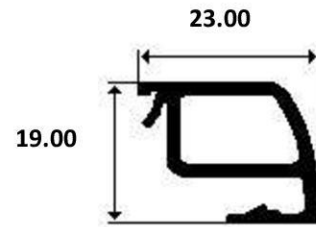

5180

PARCLOSE ARRONDIE Á
CLIP 18mm

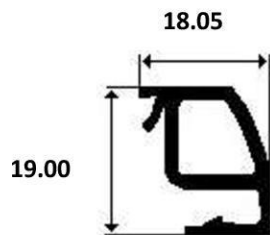

5190

PARCLOSE ARRONDIE Á
CLIP 12mm

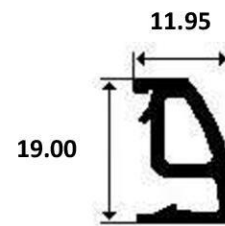

5200

COUVRE-JOINT 30mm

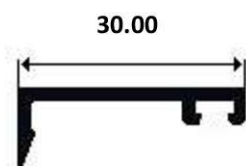

5210

COUVRE-JOINT 50mm



Alu Design System

5220

COUVRE-JOINT 80mm

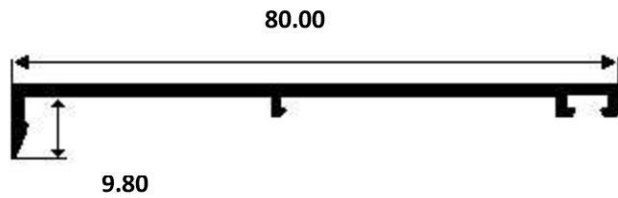

5230

BAVETTE 70mm

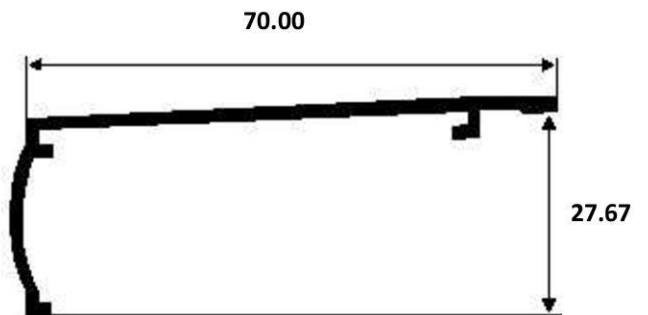

5240

BAVETTE 110mm

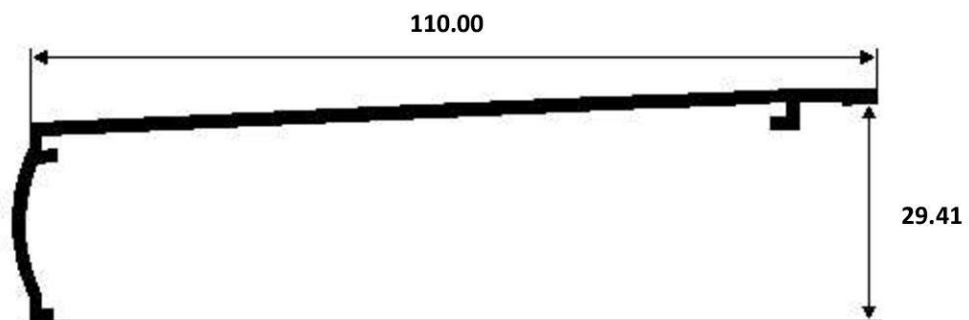

5300

H de LIAISON

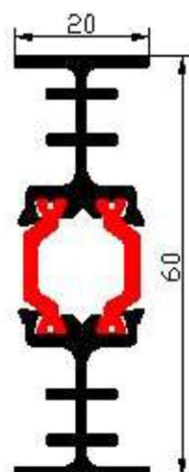

Alu Design System

5400

RAIDISSEUR 40mm

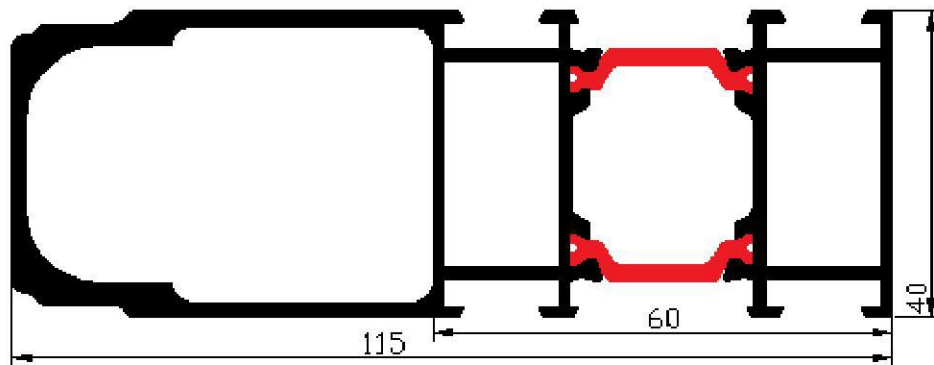

5500

RAIDISSEUR 60mm

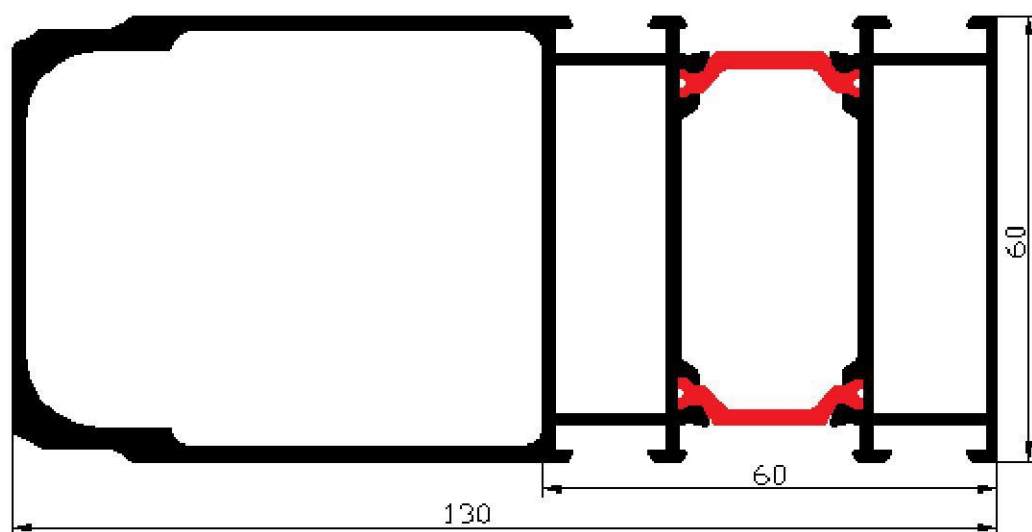

Alu Design System

5410

RÉHAUSSE 28mm

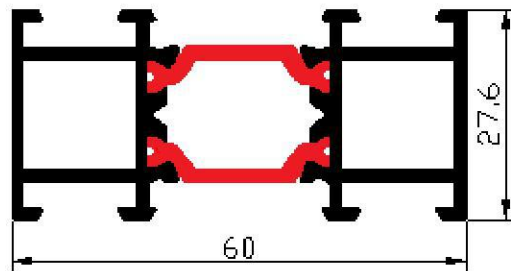

5420

RÉHAUSSE 40mm

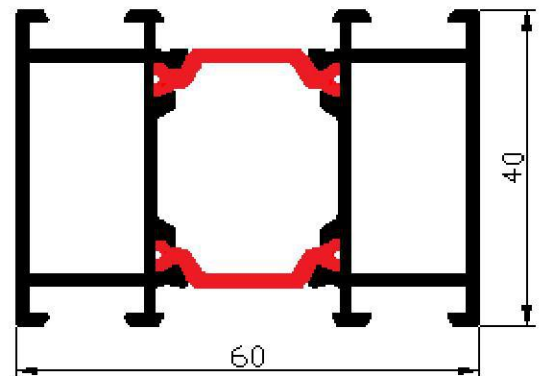

5430

RÉHAUSSE 60mm

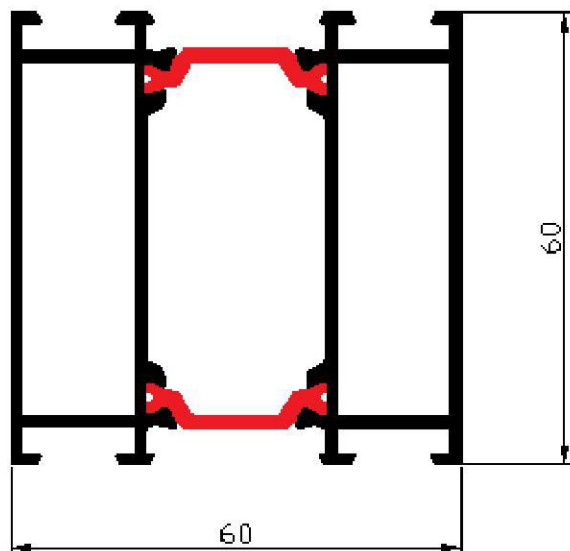

5440

RÉHAUSSE 100mm

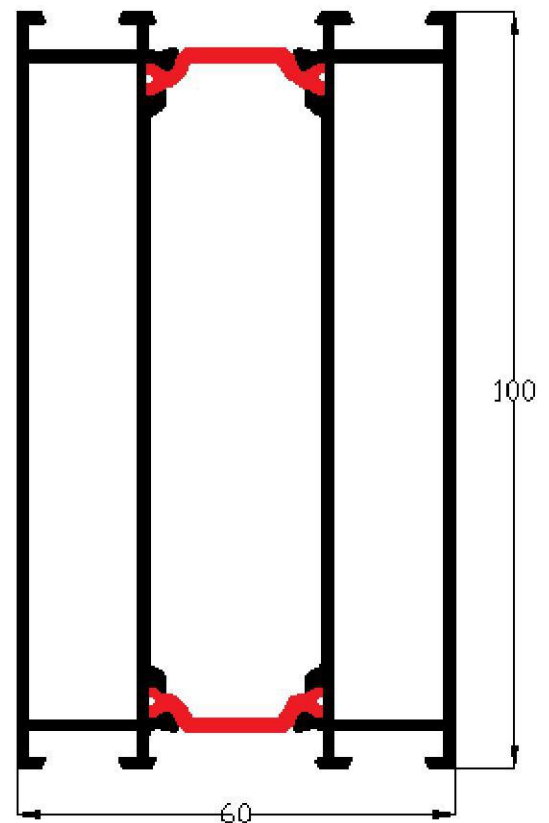

Alu Design System

5600

ANGLE VARIABLE GAUCHE

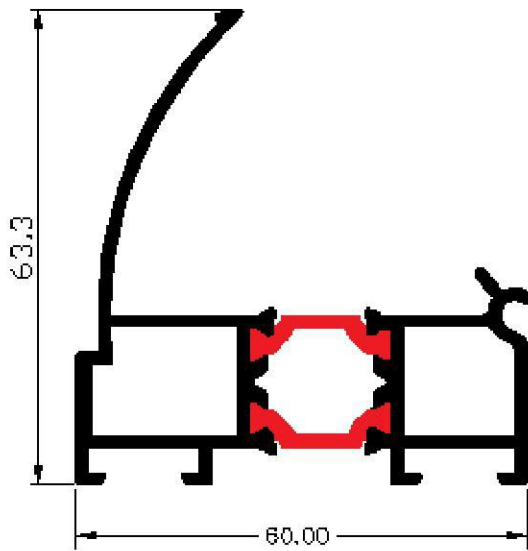

5610

ANGLE VARIABLE DROIT

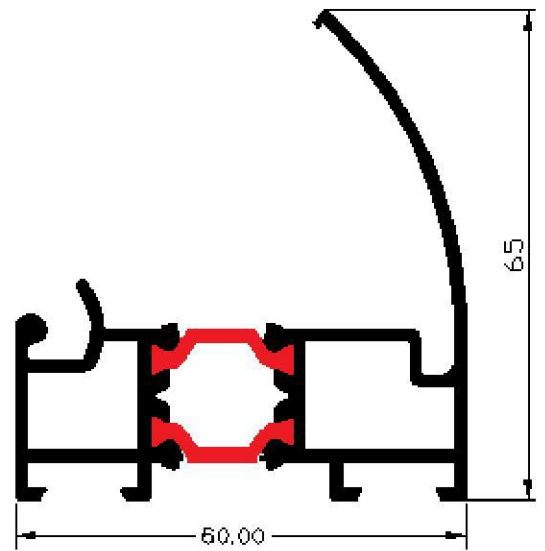

5720

TENON

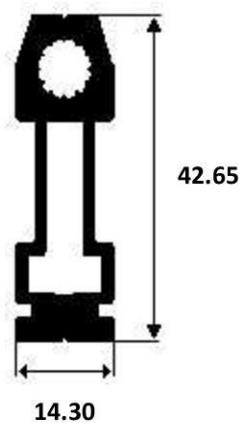

5730

ÉQUERRE VARIABLE

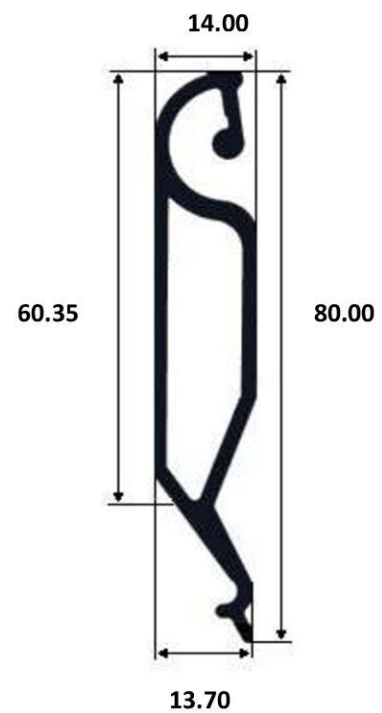

Alu Design System

5700

ÉQUERRE 37mm

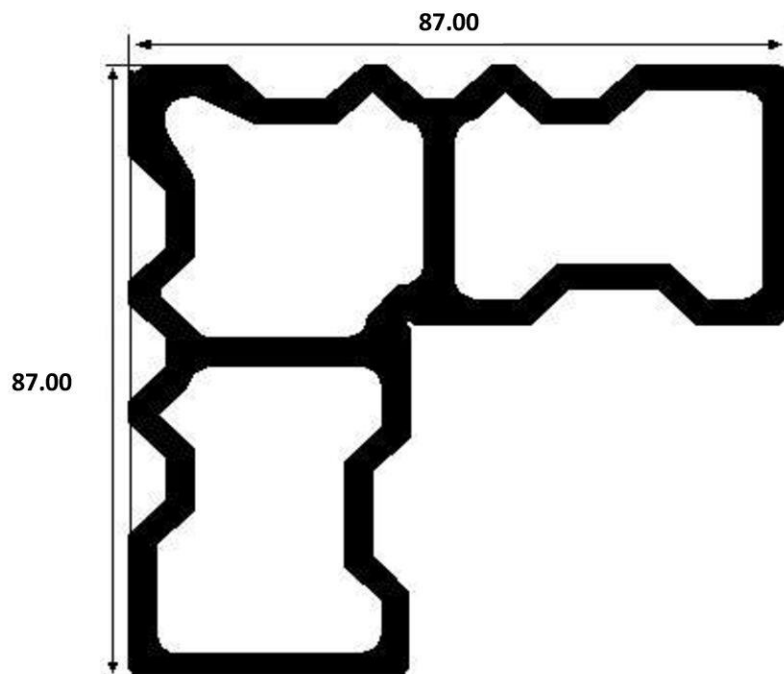

5710

ÉQUERRE 14mm

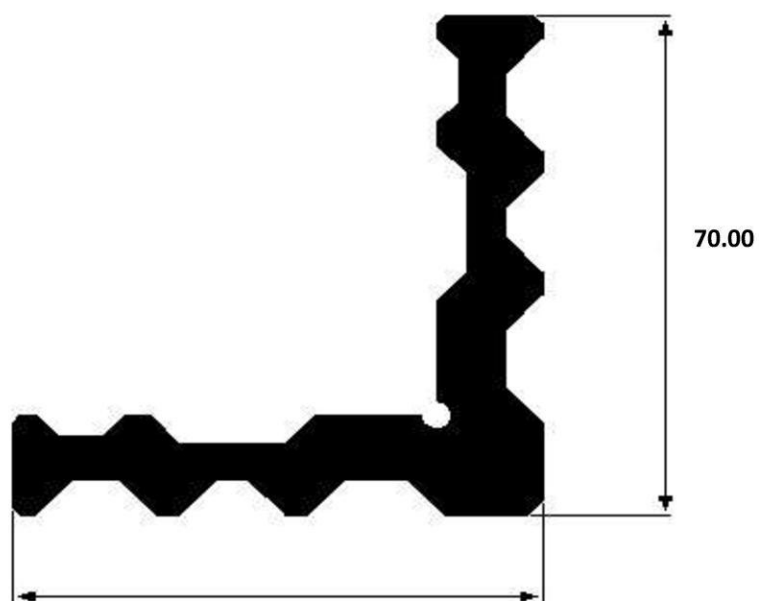

Alu Design System

5740

ÉQUERRE ARTICULÉE À USINER

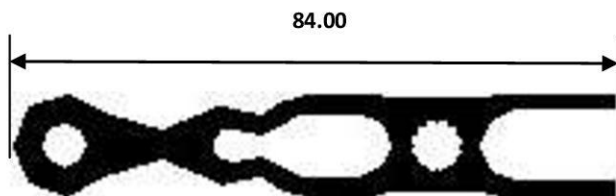

5800

RECONSTITUTION DE FEUILLEURE
À VISSER

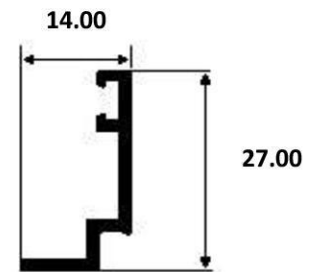

5810

PARCLOUSE DE 30 mm

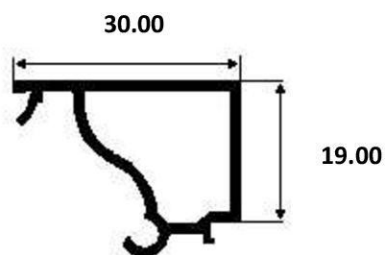





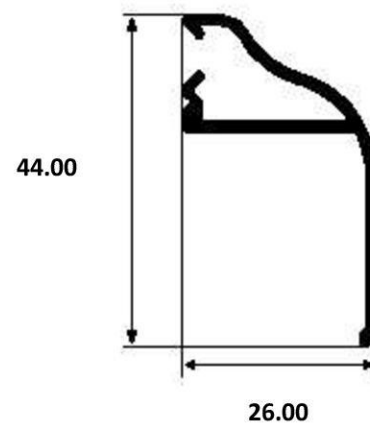

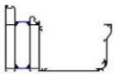

5820

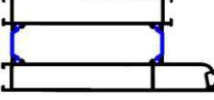

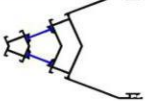
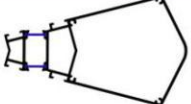

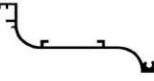
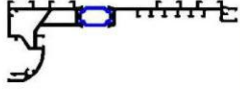
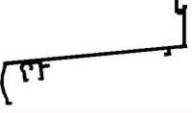
REJET D'EAU à CLIPPER

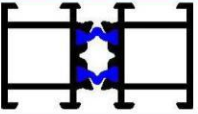
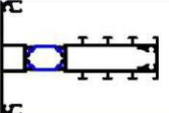

Série 6000 - Véranda

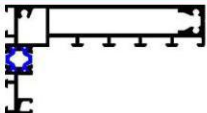
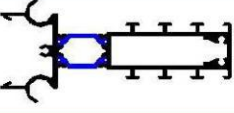
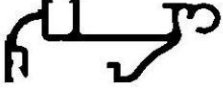
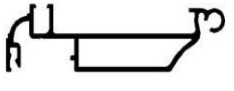
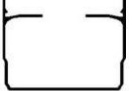
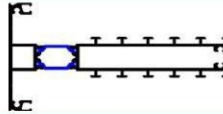
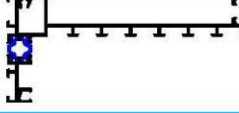
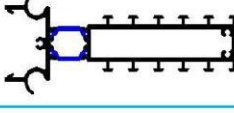
SILHOUETTE	RÉFÉRENCE ADS	RÉFÉRENCE TOLEDO	DÉSIGNATION	POIDS	PERIMÈTRE
	6000	34067	Chéneau mouluré	4,198	0,973
	6010	47156	Profil éclisse chéneau	1,311	0,497
	6020	34101	Chéneau sans réservoir	2,569	0,459
	6100	34057	Poteau intermédiaire	2,862	0,719
	6200	34058	Poteau d'angle 90°	3,171	0,728
	6300	34066	Poteau d'angle 135°	2,038	0,665
	6310	34115	Poteau d'angle 150°	3,018	0,549
	6400	47122	Capot de poteau	0,674	0,344
	6500	47123	Réhausse chéneau	0,865	0,340
	6600	34091	Accroche murale	2,317	0,744
	6610	47162	Bavette faitâge	0,929	0,389
	6620	47171	Profil charnière	0,221	0,108
	6646	34094	Profil de jonction poutre	0,916	0,265
	6700	34093	Chevron de 100mm	2,343	0,607

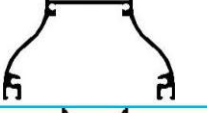
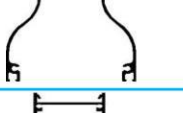
Suite... Série 6000

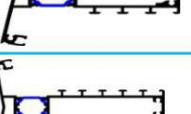
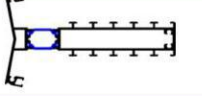
SILHOUETTE	RÉFÉRENCE ADS	RÉFÉRENCE TOLEDO	DÉSIGNATION	POIDS	PERIMÈTRE
	6710	34096	Petit chevron de rive de 100mm	2,112	0,501
	6720	34097	Petit chevron articulé de 100mm	2,145	0,580
	6730	47174	Profil aretier articulé	0,917	0,350
	6740	47175	Profil noue articulée	1,384	0,396
	6750	47179	Capot de chevron	1,559	0,579
	6800	34092	Chevron de 133mm	2,782	0,746
	6810	34095	Chevron de rive de 133mm	2,474	0,603
	6820	34098	Aretier articulé de 133mm	2,584	0,719
	6830	47166	Enjoliveur de capot	0,229	0,116
	6840	47167	Capot de 27mm	0,889	0,377
	6850	47168	Capot de 48mm	0,985	0,431
	6860	47169	Capot de 66mm	1,157	0,504
	6870	47170	Capot de 80mm	1,278	0,560
	6900	34099	Aretier de 100mm	2,498	0,625
	6910	34100	Aretier de 133mm	2,937	0,764

Alu Design System

6000

CHENEAU MOULURÉ

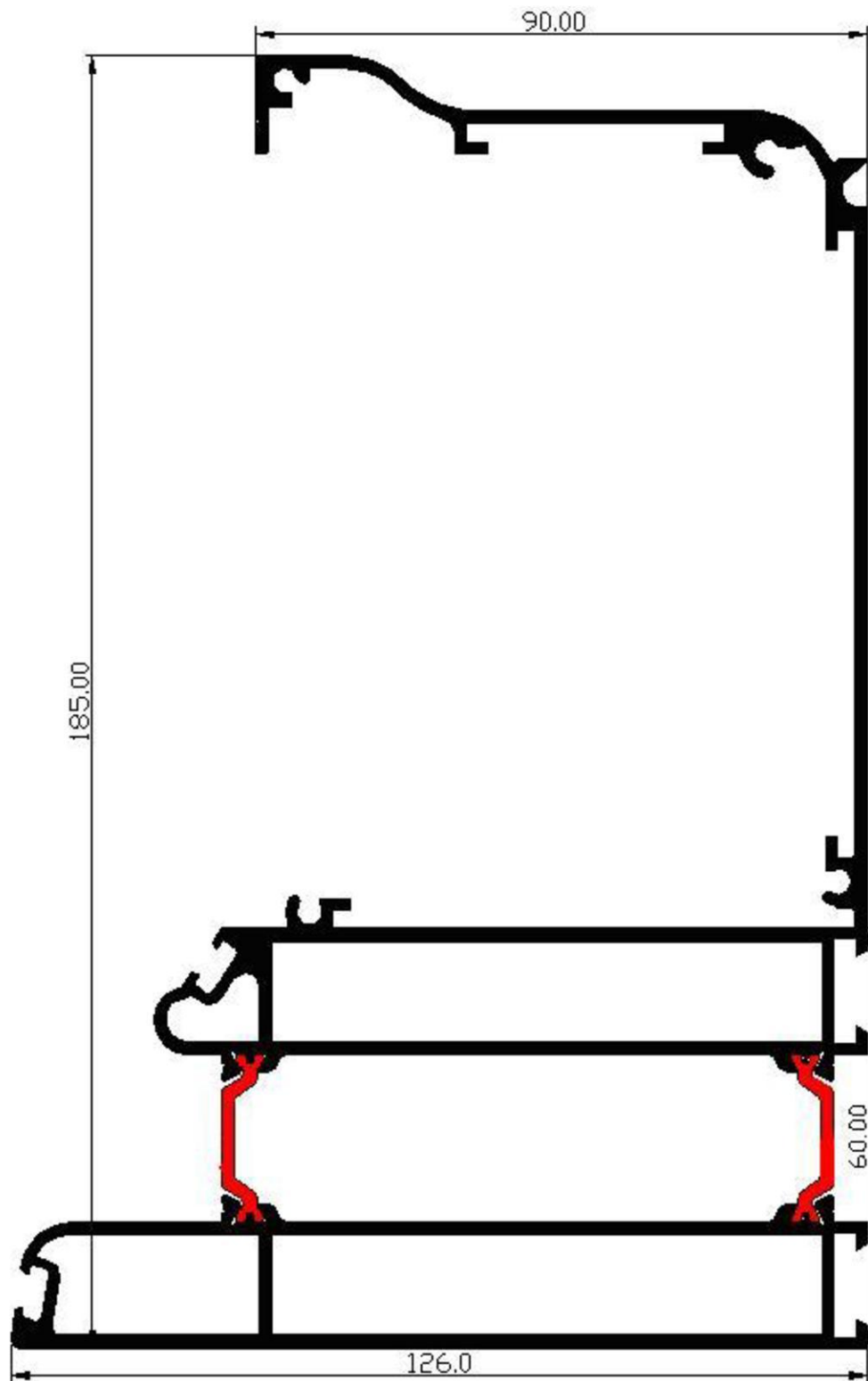

Alu Design System

6010

PROFIL ÉCLISSE de CHÉNEAU

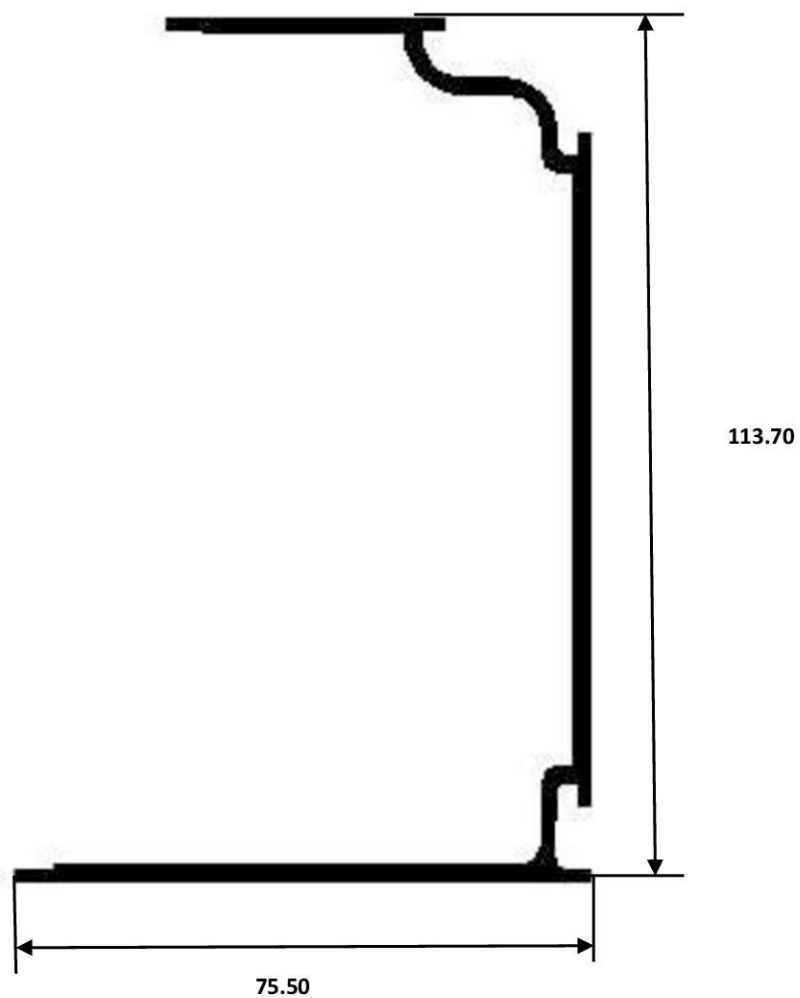

Alu Design System

6020

CHÉNEAU SANS RÉSERVOIR

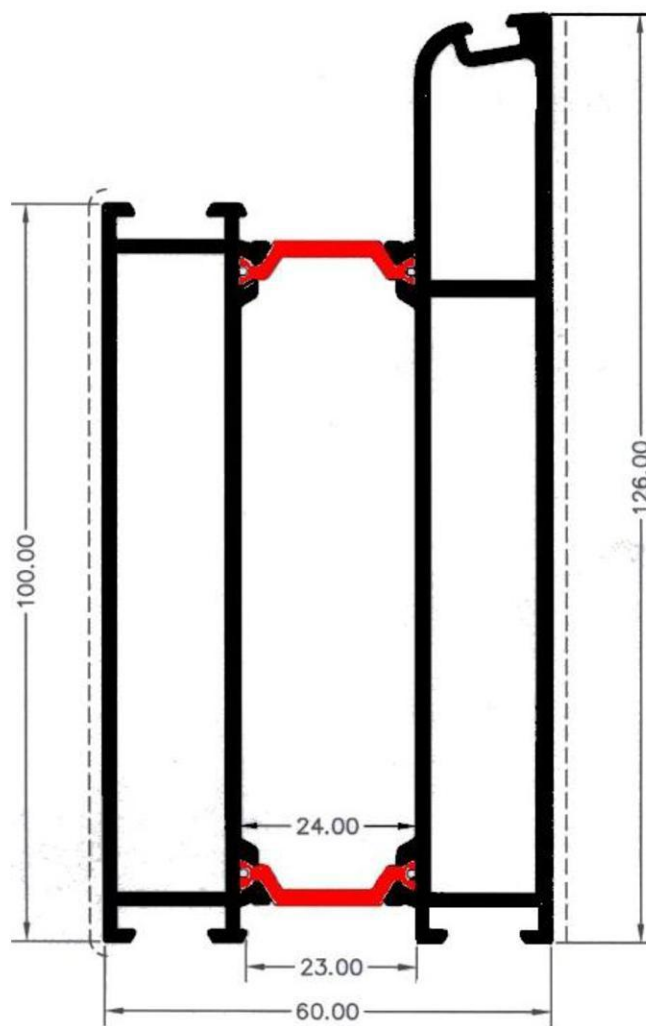

Alu Design System

6100

POTEAU INTERMÉDIAIRE

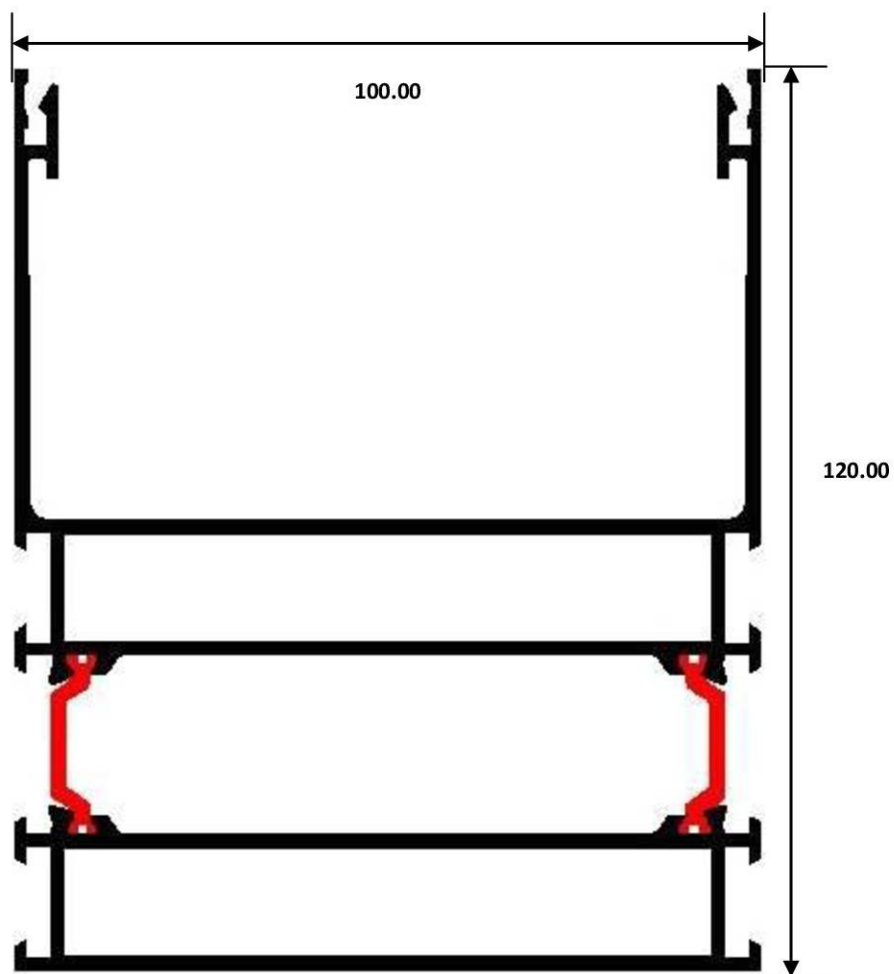

Alu Design System

6200

POTEAU D'ANGLE 90°

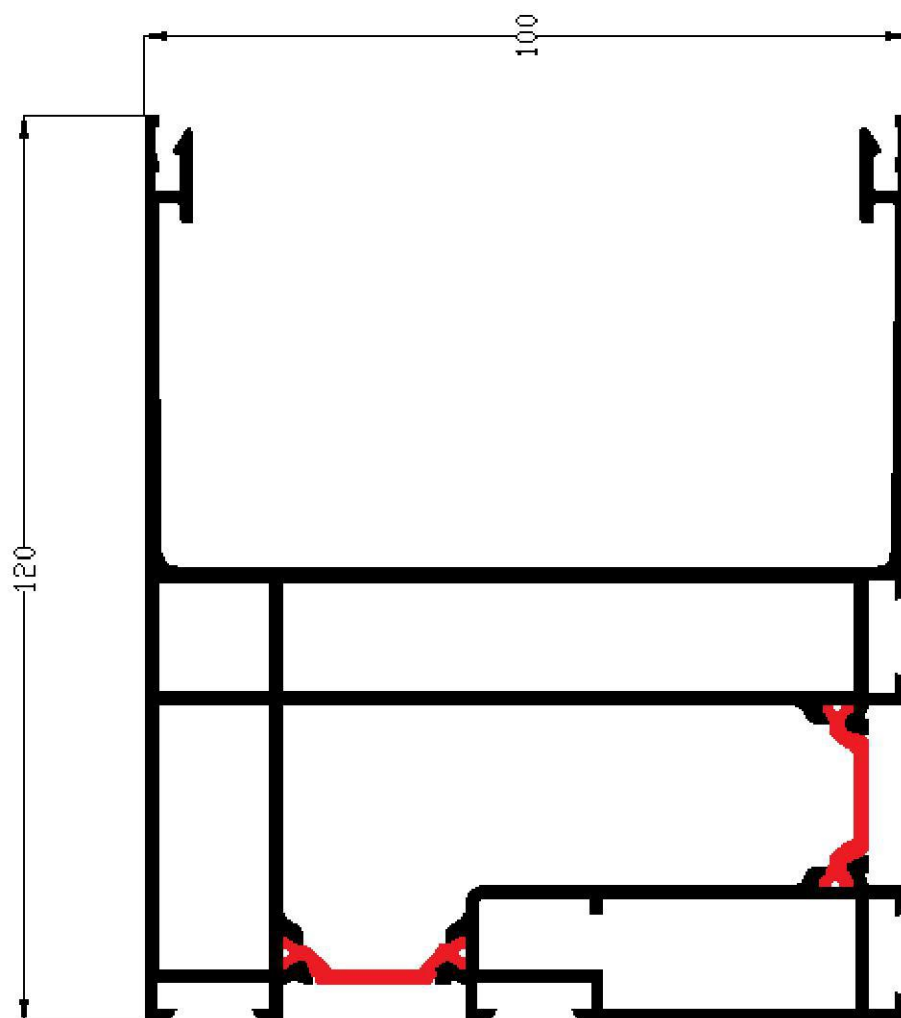

Alu Design System

6300

POTEAU D'ANGLE 135°

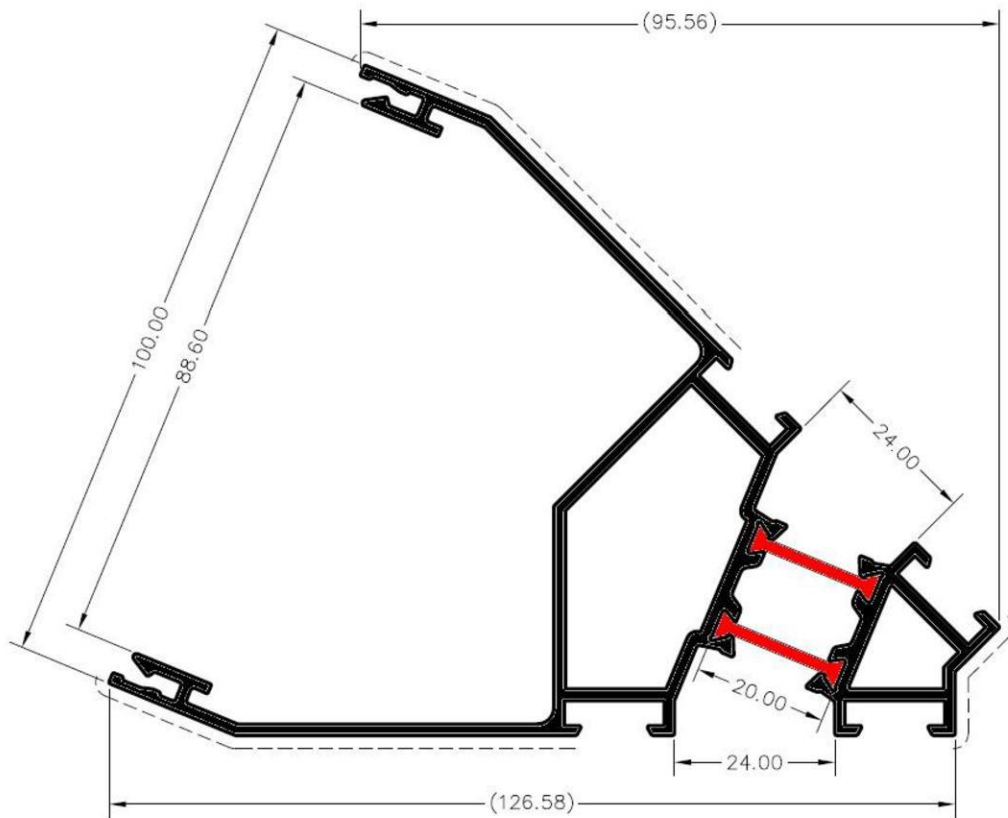

6400

CAPOT POTEAU

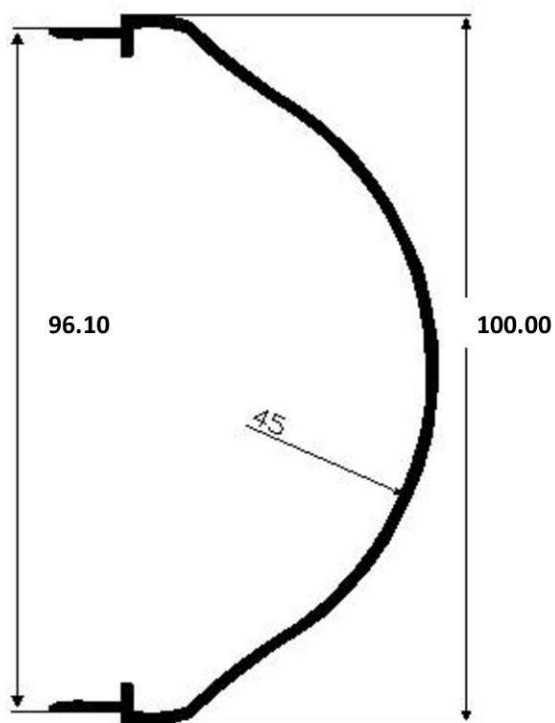

6500

RÉHAUSSE CHÉNEAU

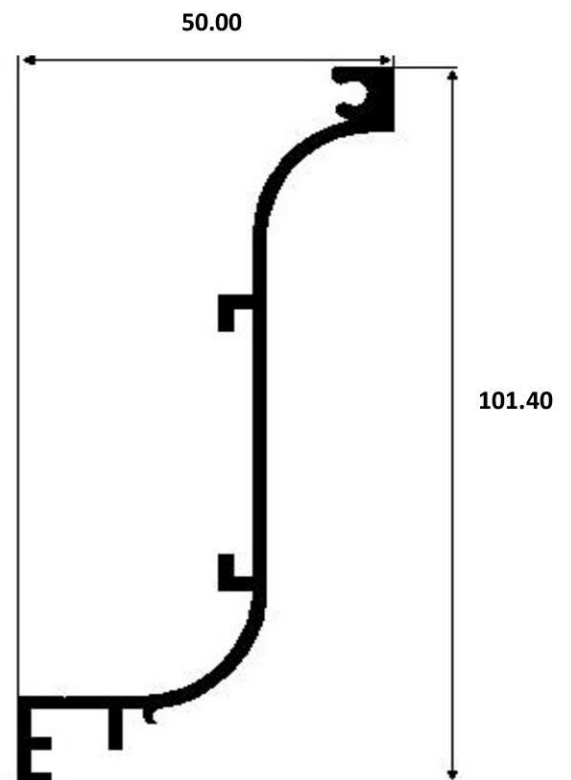

Alu Design System

6310

POTEAU D'ANGLE 150°

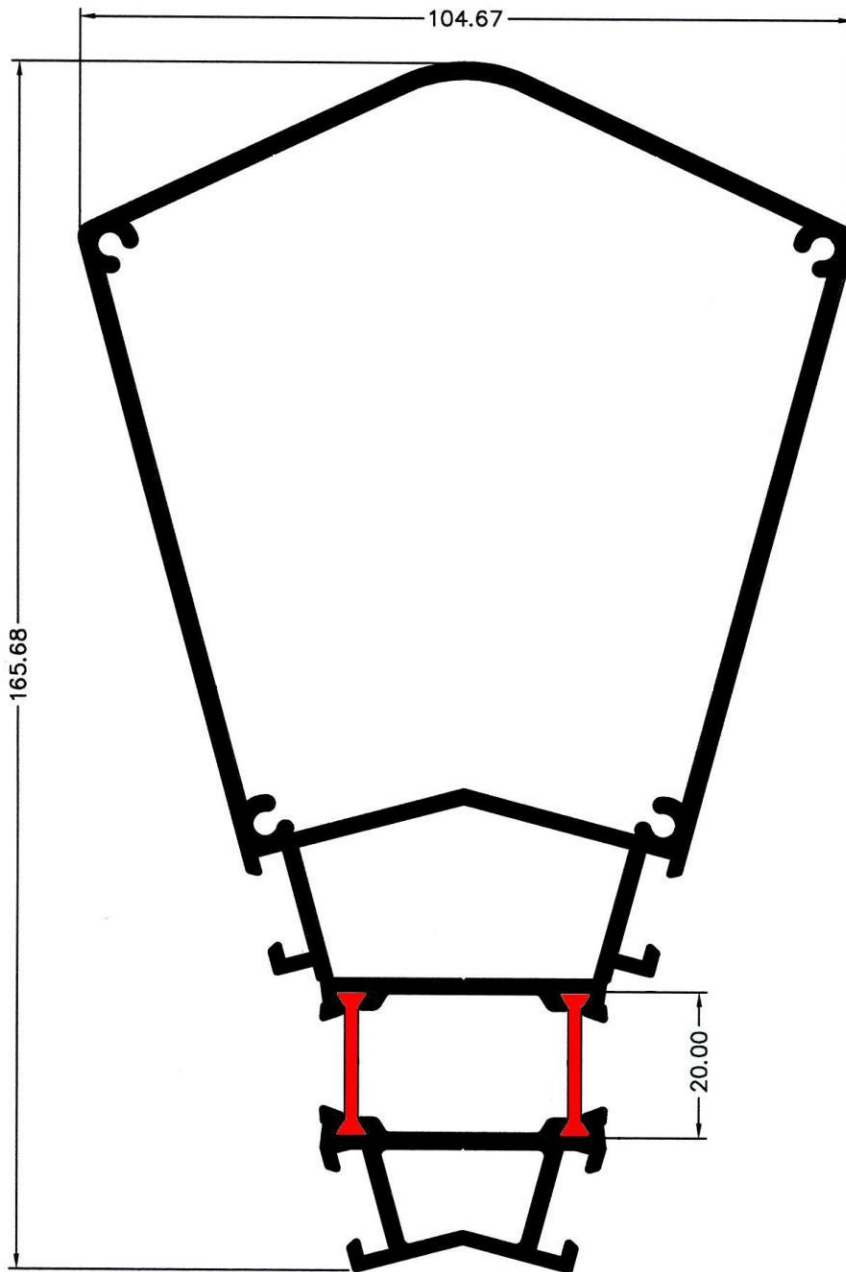

Alu Design System

6600

ACCROCHE MURALE

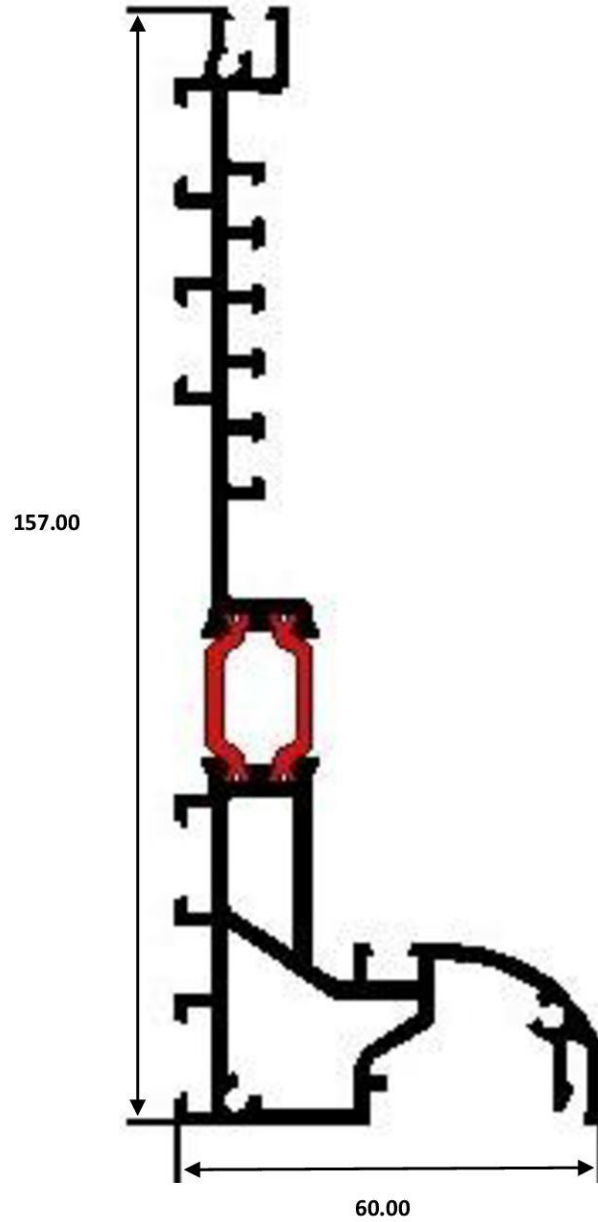

Alu Design System

6610

BAVETTE de FAITÂGE

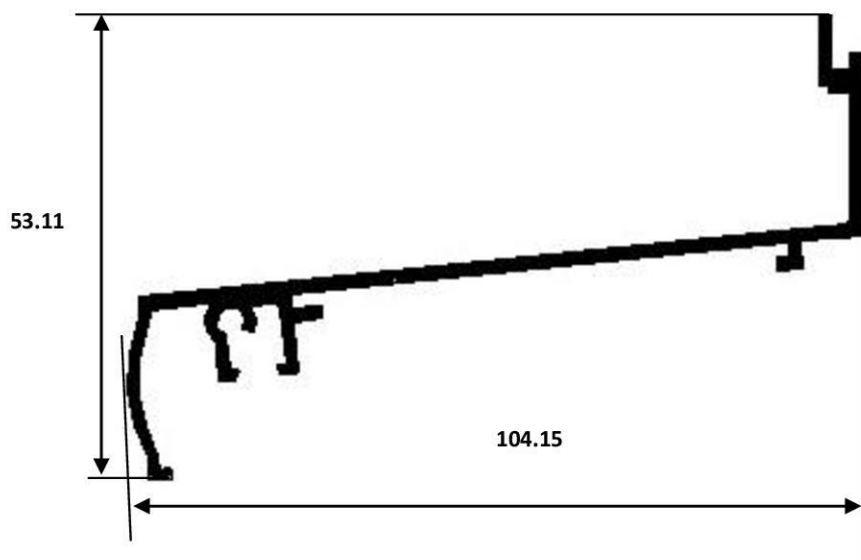

6620

PROFIL CHARNIÈRE

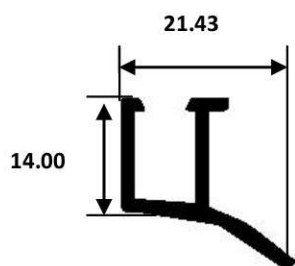

6646

JONCTION POUTRE

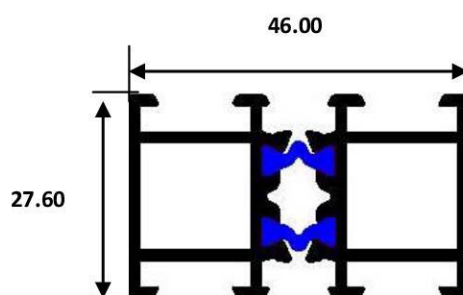

Alu Design System

6700

CHEVRON de 100mm

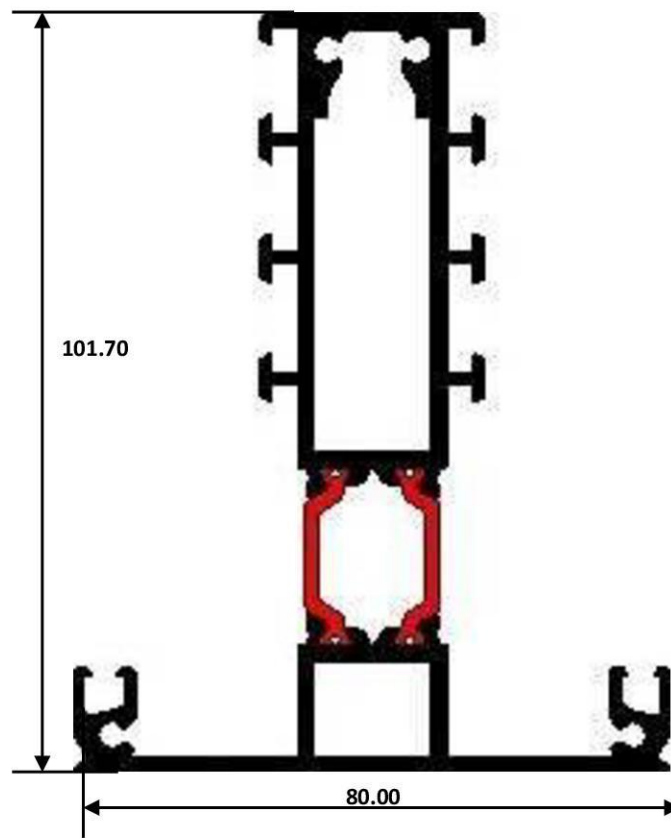

6710

PETIT CHEVRON de RIVE 100mm

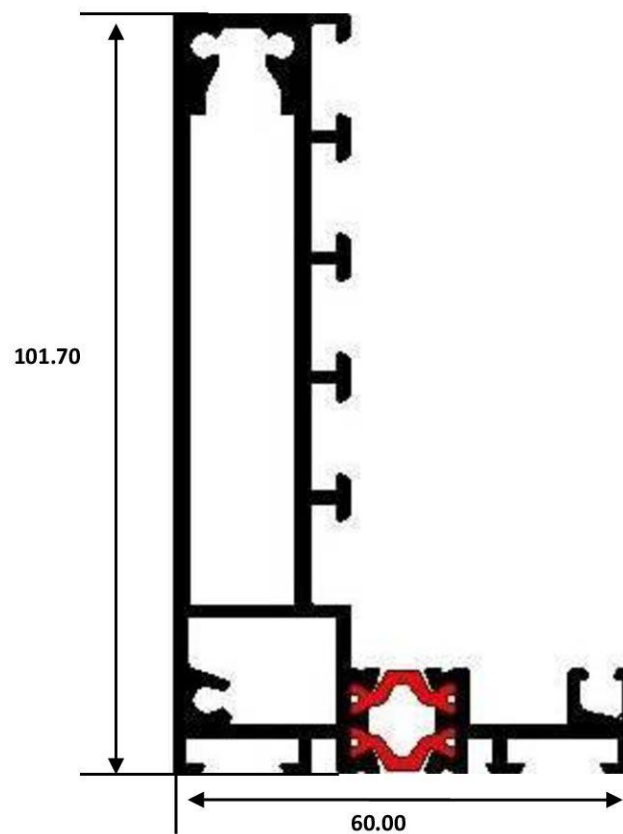

Alu Design System

6720

PETIT CHEVRON ARTICULÉ de 100mm

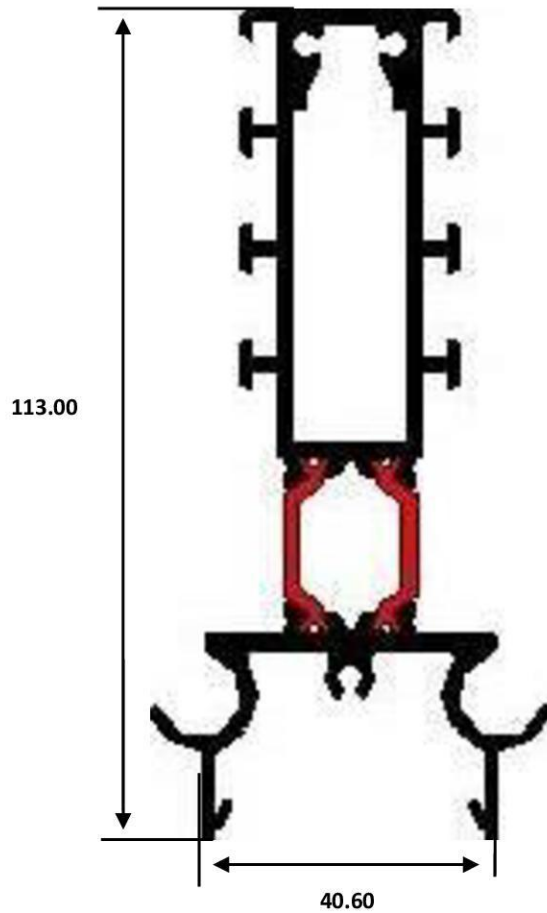

6730

ARETIER ARTICULÉ

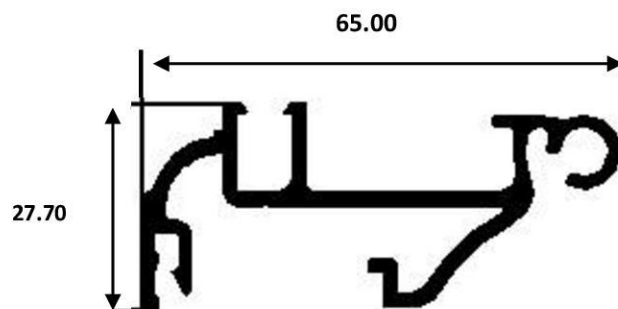

Alu Design System

6740

NOUE ARTICULÉE

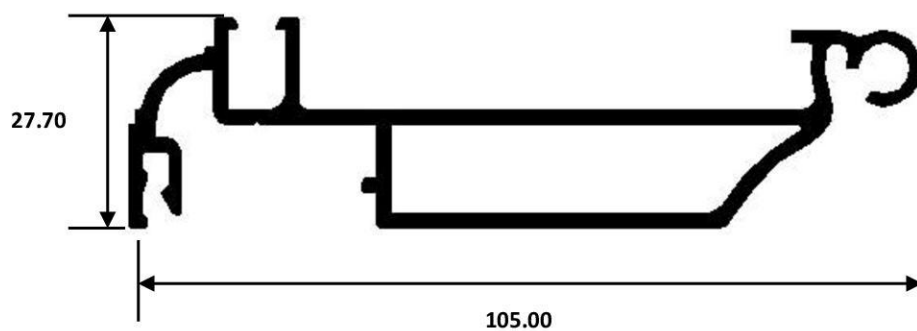

6750

CAPOT de CHEVRON

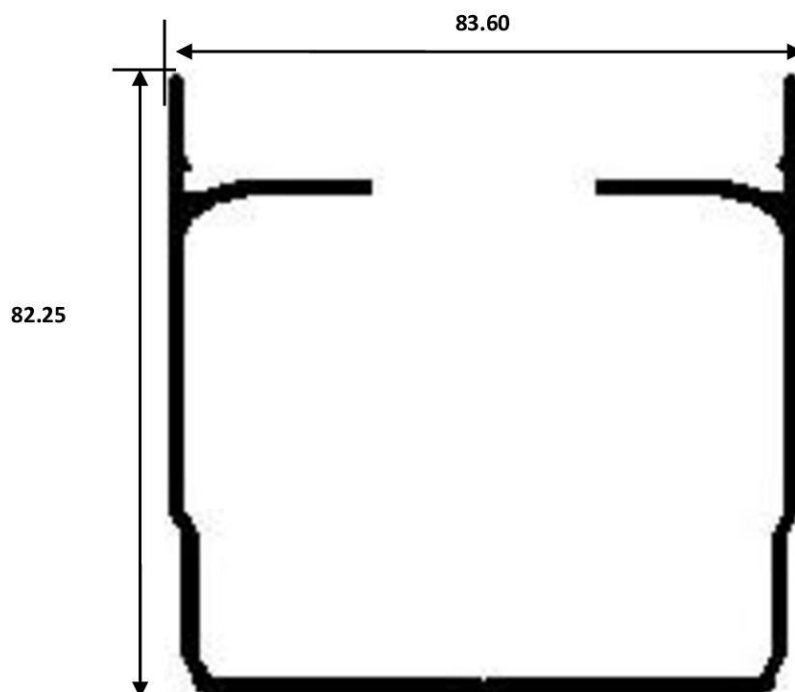

Alu Design System

6800

CHEVRON de 133mm

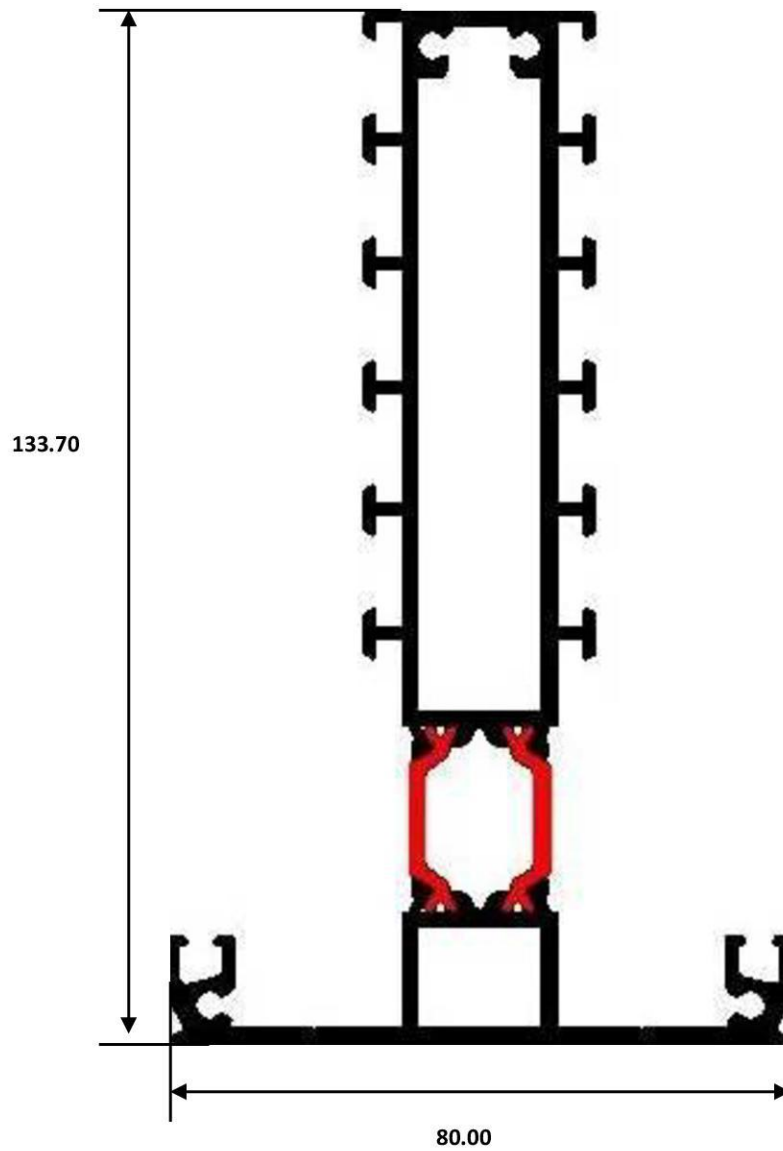

Alu Design System

6810

CHEVRON de RIVE 133mm

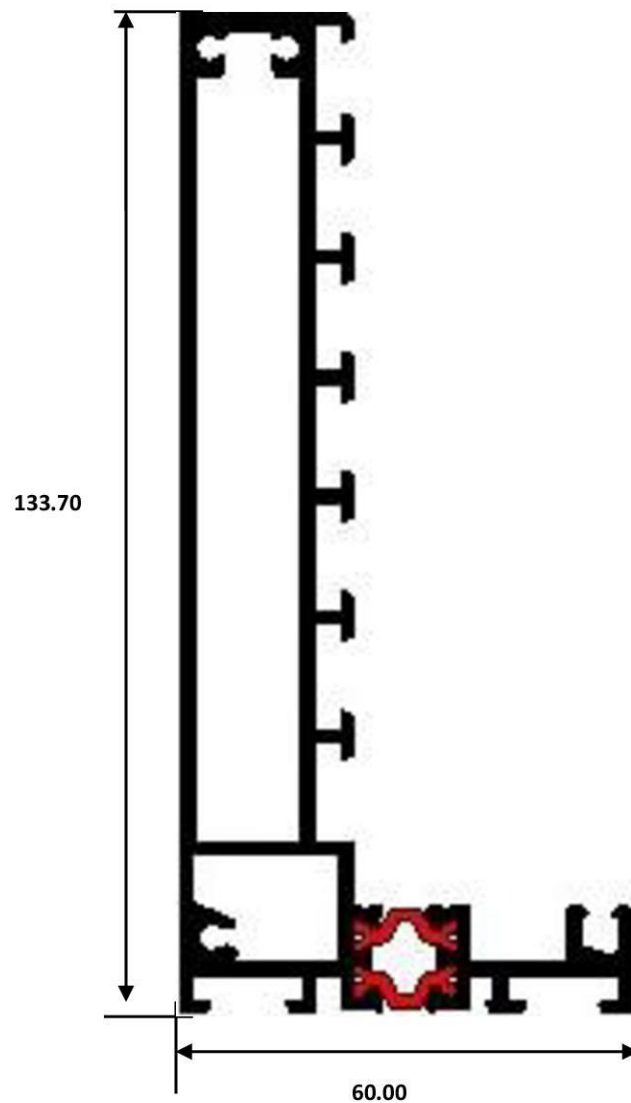

6830

ENJOLIVEUR DE CAPOT

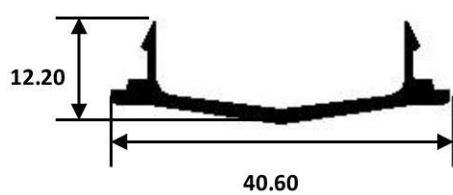

6840

CAPOT de SERRAGE 27mm

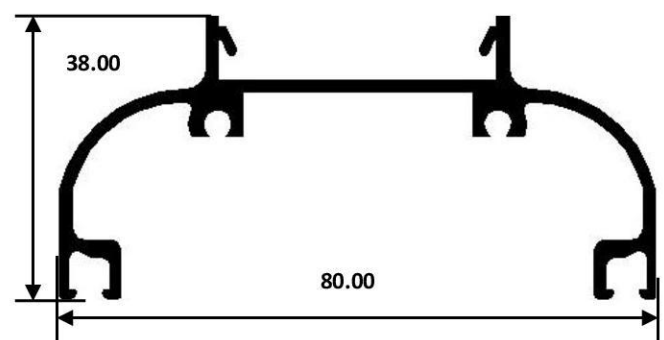

Alu Design System

6820

ARETIER ARTICULÉ de 133mm

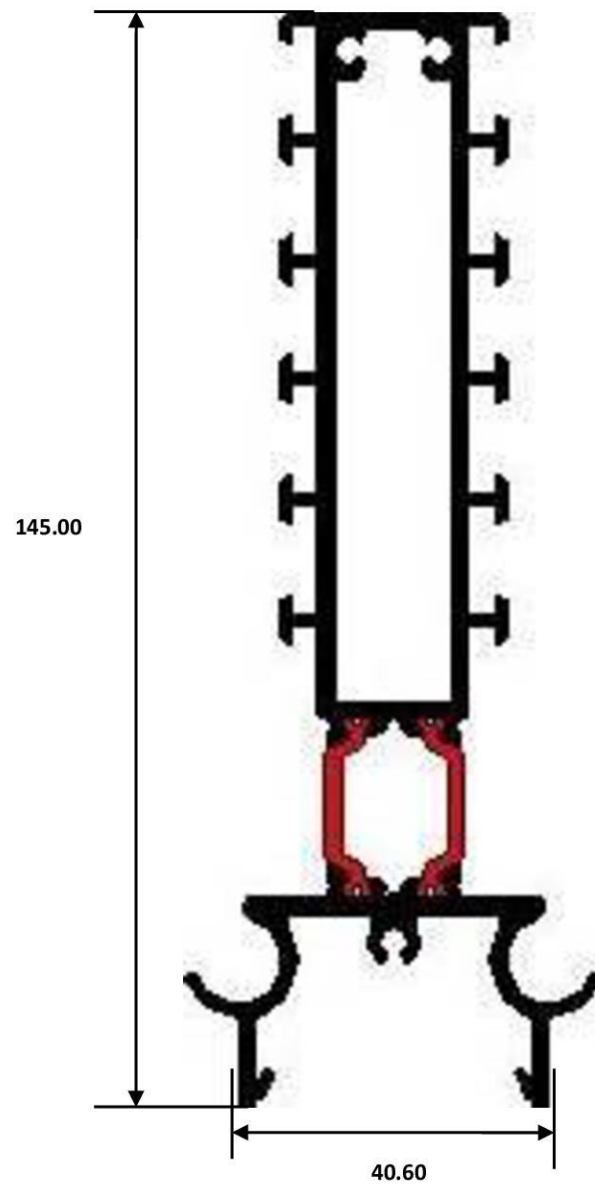

Alu Design System

6850

CAPOT de SERRAGE 48mm

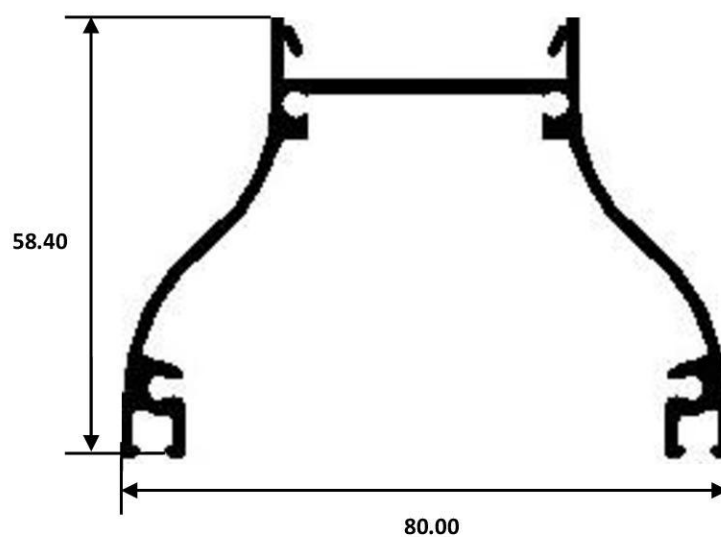

6860

CAPOT de SERRAGE 66mm

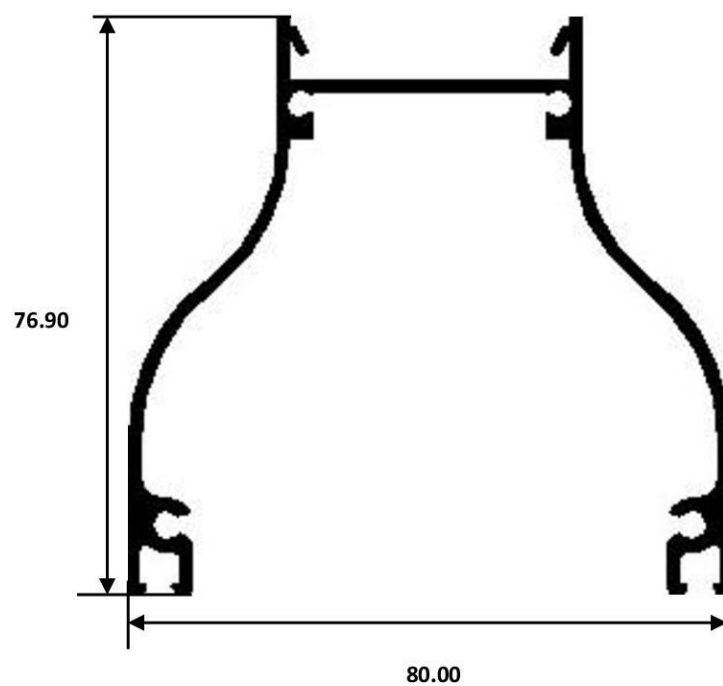

Alu Design System

6870

CAPOT de SERRAGE 80mm

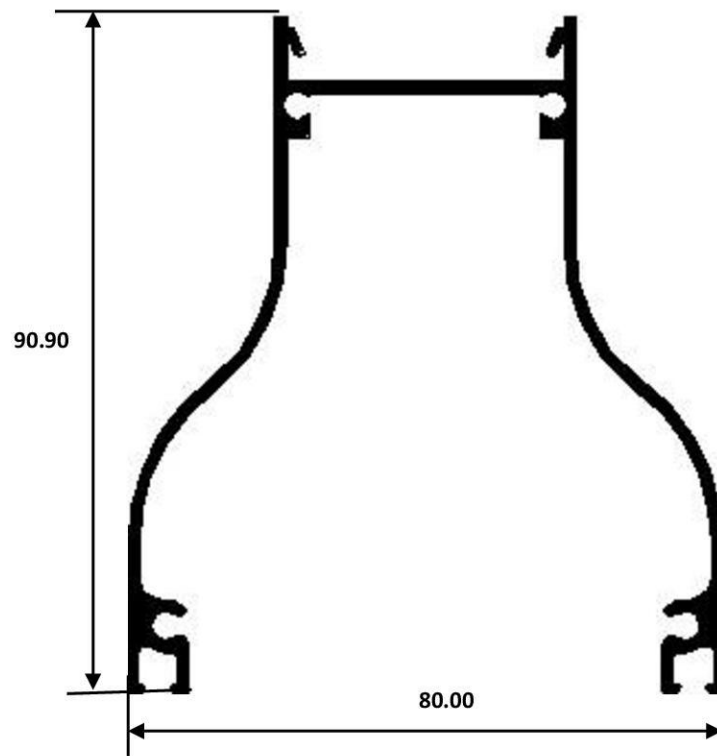

6900

ARETIER de 100mm

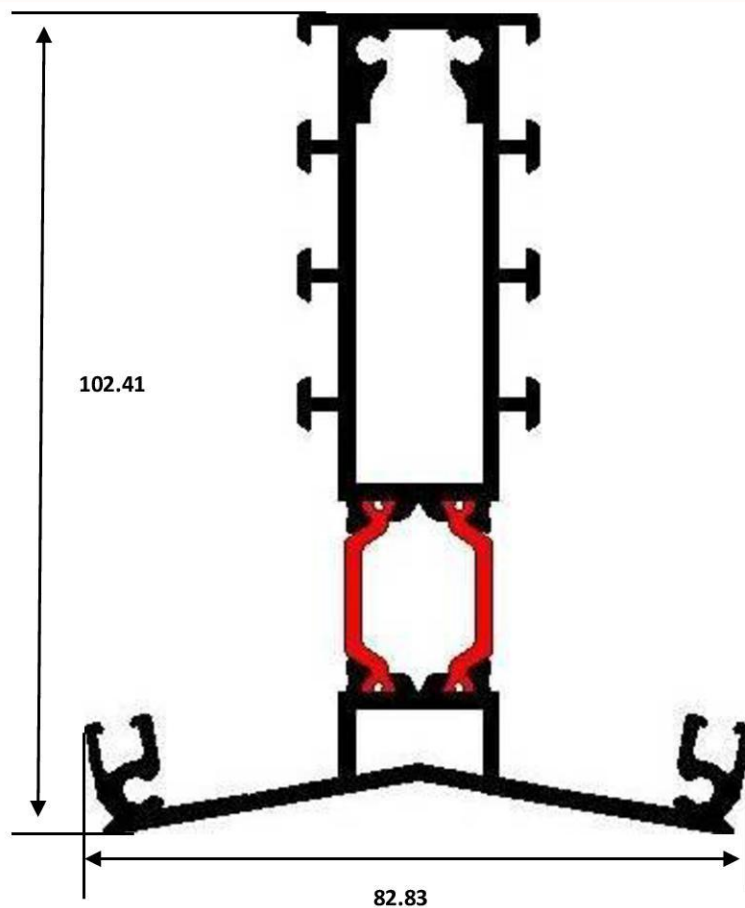







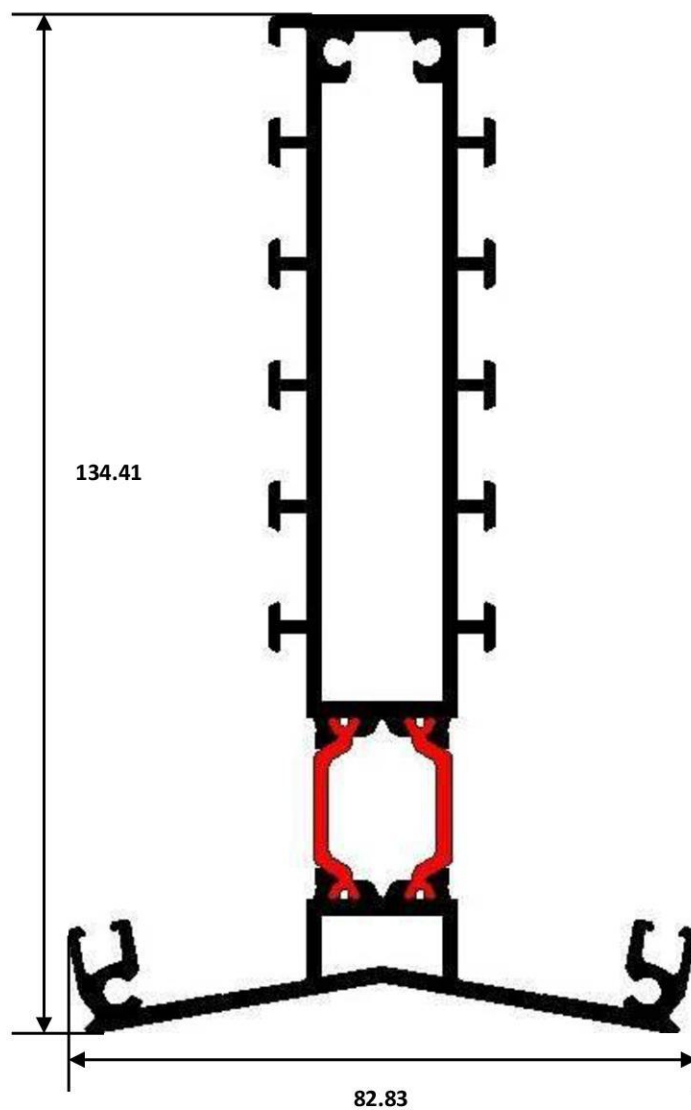

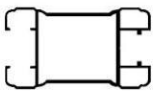

Alu Design System

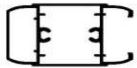
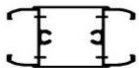
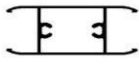
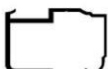
6910

ARETIER de 133mm

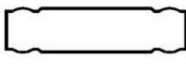

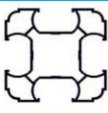
Série 7000 - Portail

SILHOUETTE	RÉFÉRENCE ADS	RÉFÉRENCE TOLEDO	DÉSIGNATION	POIDS	PERIMÈTRE
	7000	47108	Montant pour battant ou traverse supérieure pour coulissant	2,063	0,462
	7100	47109	Traverse inférieure pour coulissant	3,541	0,536
	7200	47110	Traverse haute et basse	1,777	0,312
	7300	47111	Montant ou traverse centrale	1,683	0,383
	7400	47112	Petite traverse	1,258	0,322
	7500	47113	Guide traverse supérieure	1,210	0,379
	7600	47044	Couvre battement	0,996	0,328
	7610	47045	Couvre battement	1,302	0,321
	7700	47114	Parclose pour portail	0,257	0,125
	7800	47115	Capot de poteau du 7000ADS	0,204	0,106
	7900	47116	Lame barreau de 90mm	0,956	0,226
	7910	9101	Lame barreau de 120mm	1,283	0,601
	71000	47136	Poteau de clôture 80 X 80	2,474	0,516
	71100	47137	Poteau de départ	1,289	0,280
	71200	47138	Lame en Z	1,066	0,243

Série Garde-corps

SILHOUETTE	RÉFÉRENCE ADS	RÉFÉRENCE TOLÉDO	DÉSIGNATION	POIDS	PERIMÈTRE
	72300	4817	Capot main courante bombée	0,486	0,235
	72400	4818	Main courante elliptique	1,039	0,458
	72410	4805	Balustre ovale	0,294	0,075
	72430	4808	Lisse horizontale	0,603	0,192
	72440	4809	Closier pour lisse horizontale	0,245	0,121
	72450	4810	Poteau 40 X 20	1,191	0,119
	72460	4811	U de support de vitrage	0,507	0,129

Alu Design System

7000

MONTANT BATTANT OU TRAVERSE
SUPÉRIEURE COULISSANT

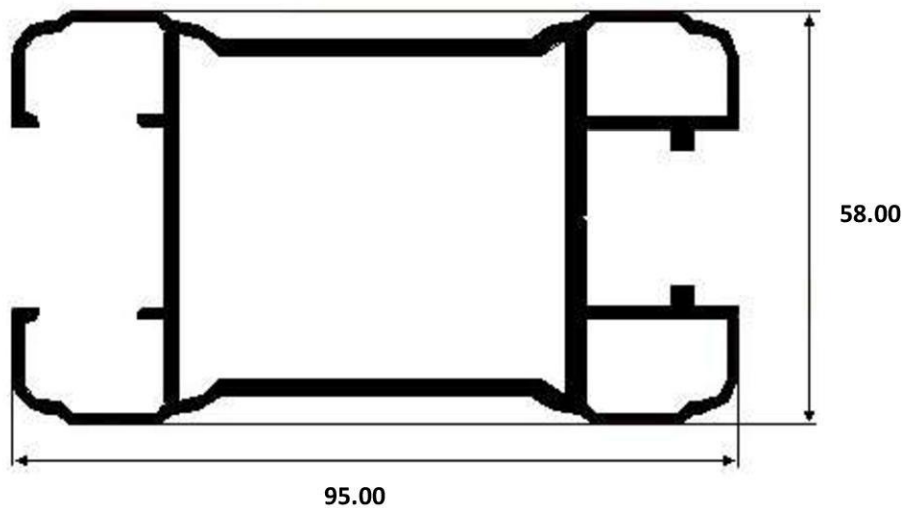

7100

TRAVERSE INFÉRIEURE POUR COULISSANT

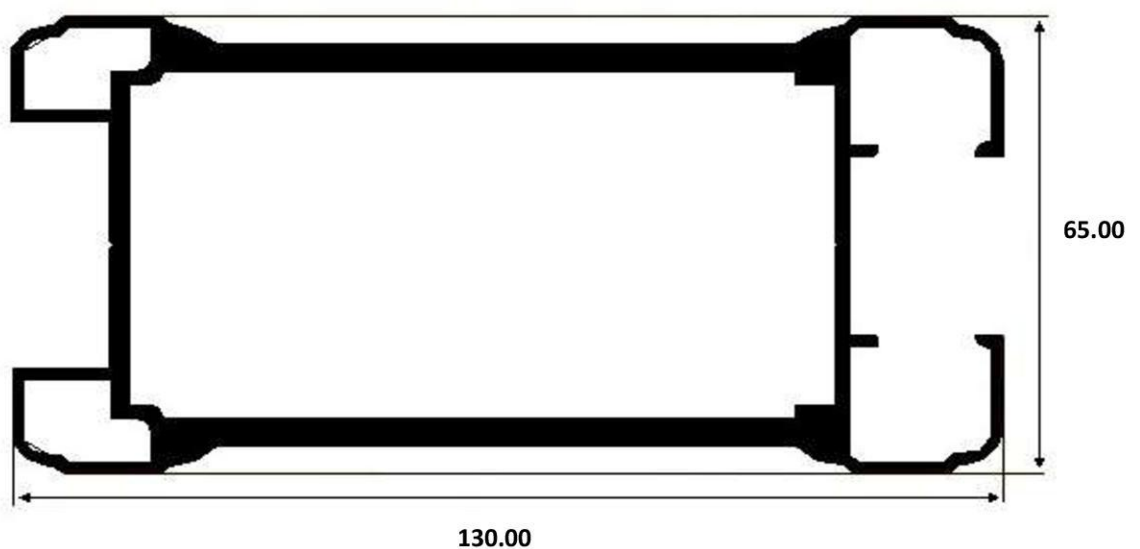

Alu Design System

7200

TRAVERSE HAUTE
ET BASSE

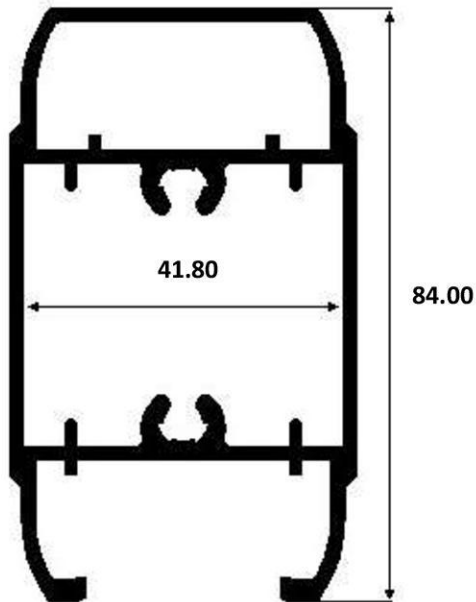

7300

MONTANT OU TRAVERSE
CENTRALE

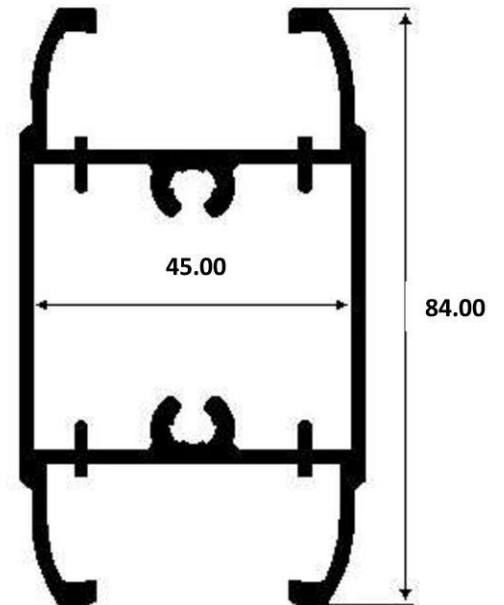

7400

PETITE TRAVERSE

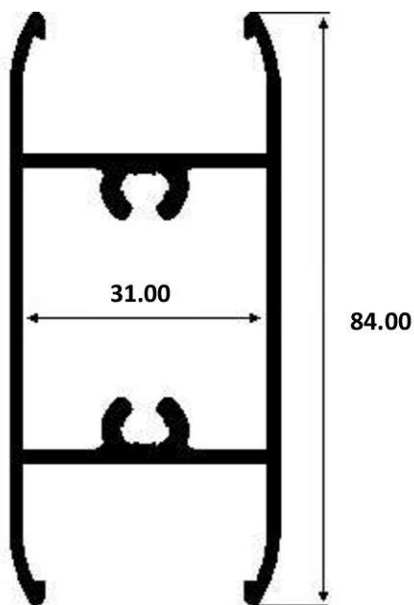

7500

GUIDE de TRAVERSE
SUPÉRIEURE

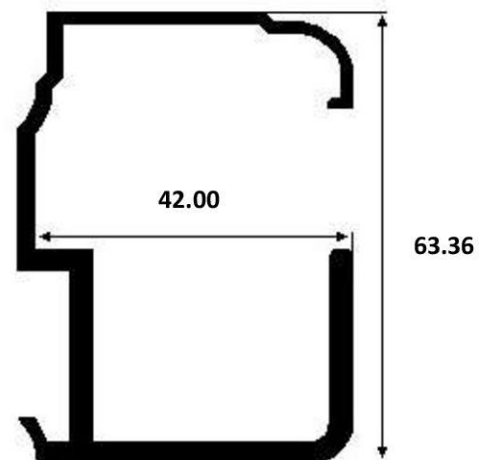

Alu Design System

7600

COUVRE BATTEMENT

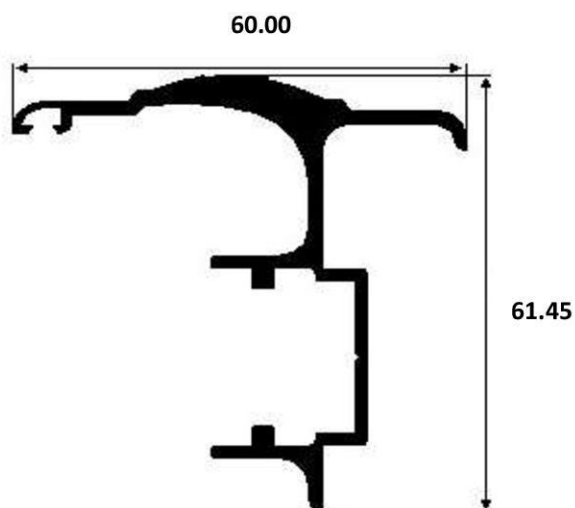

7610

COUVRE BATTEMENT POUR
GACHE ELECTRIQUE

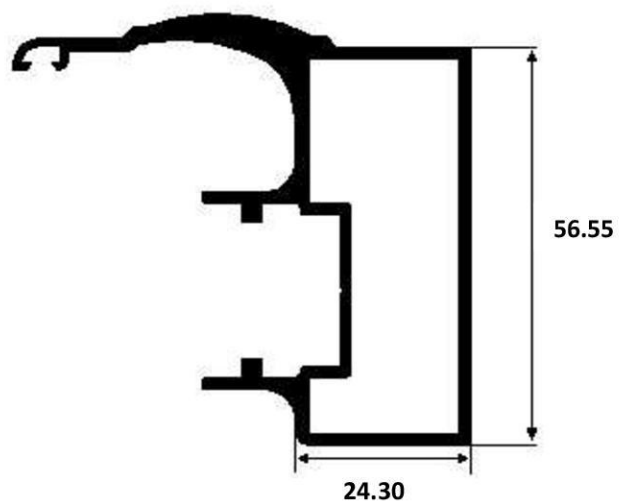

7700

PARCLOUSE DE PORTAIL

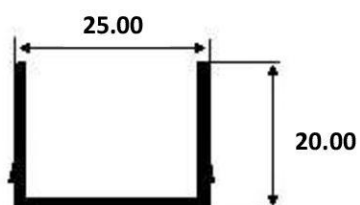

7800

CAPOT DE POTEAU
ADS 7000

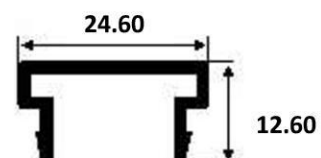

7900

LAME BARREAU DE 90 mm

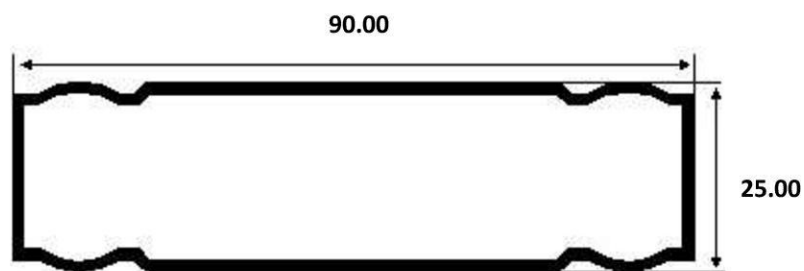

Alu Design System

7910

LAME BARREAU de 120 mm



Alu Design System

71000

POTEAU DE CLÔTURE 80X80

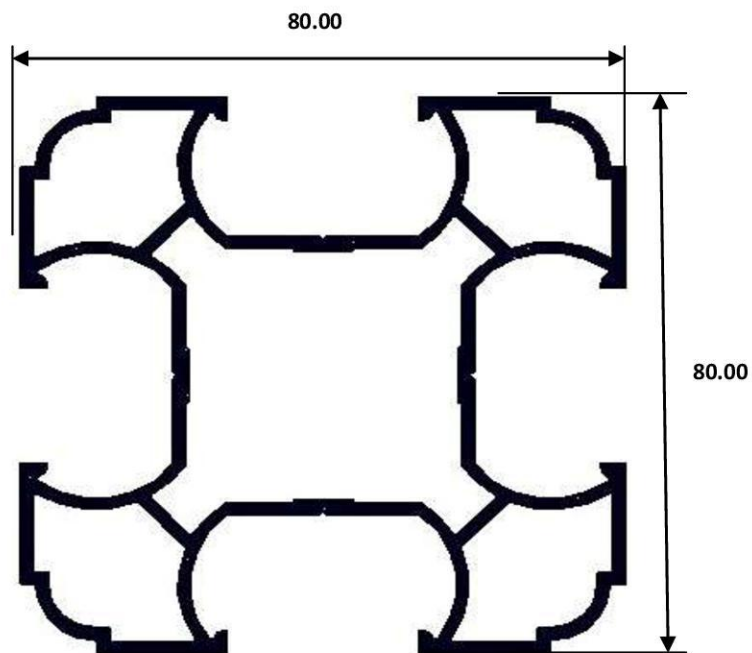

71100

POTEAU DE DÉPART

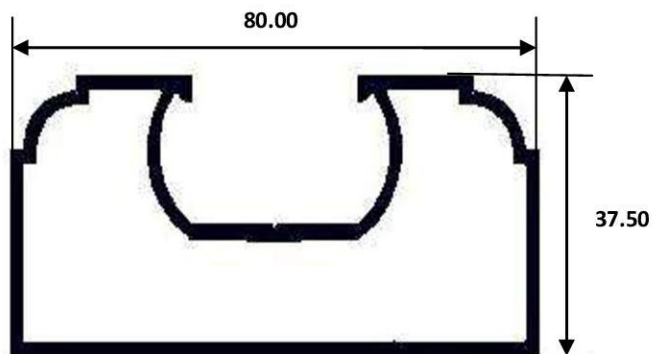

71200

LAME EN Z

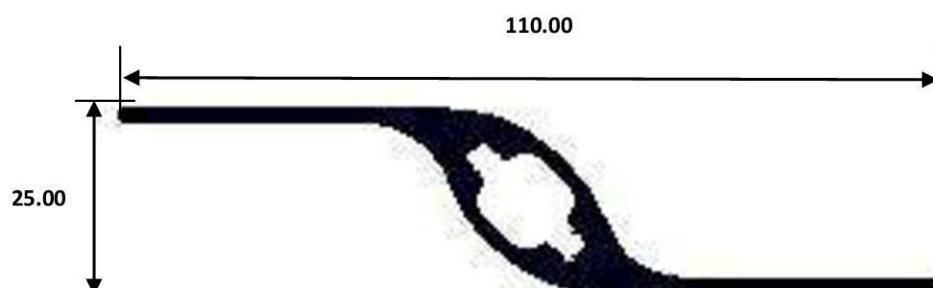

Alu Design System

72400

MAIN COURANTE ÉLLIPTIQUE

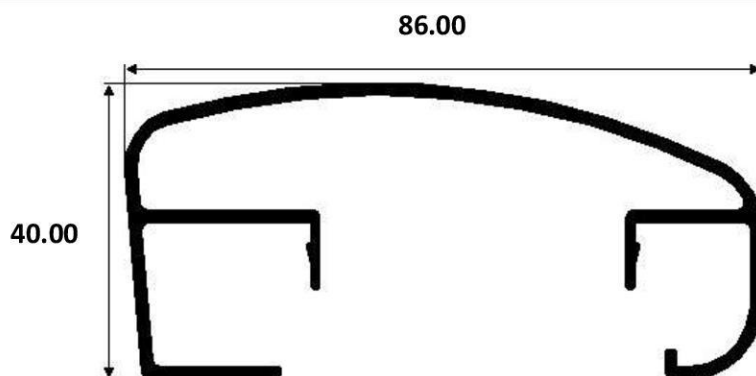

72410

BALUSTRE OVALE

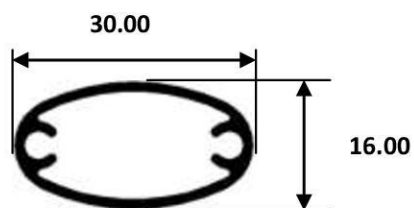

72300

CAPOT MAIN COURANTE BOMBÉE



72430

LISSE HORIZONTALE

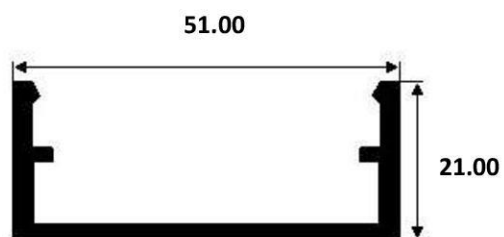

72440

CLOISIR POUR LISSE HORIZONTALE

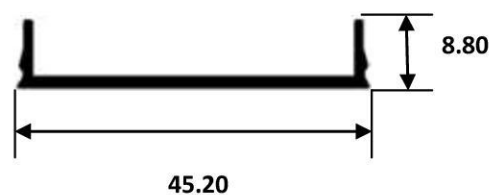

Alu Design System

72450

POTEAU 40 X 20

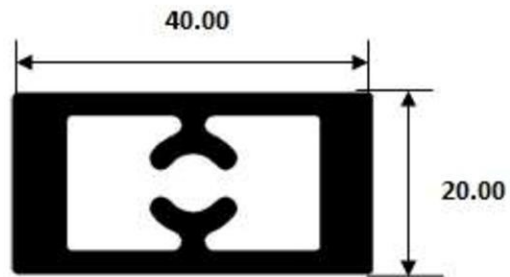





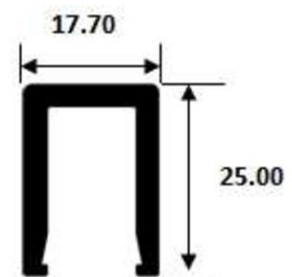

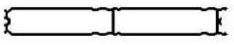

72460

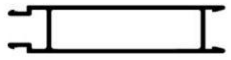
U de SUPPORT DE VITRAGE

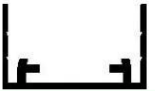

Série 8000 - Volet battant

SILHOUETTE	RÉFÉRENCE ADS	RÉFÉRENCE TOLEDO	DÉSIGNATION	POIDS	PERIMÈTRE
	8000	47092	Lame double de 180mm	1,938	0,454
	8100	9112	Double lame lisse	2,203	0,540
	8110	5185	Lame simple lisse	1,366	0,533
	8200	47187	Double lame 180mm "Grain d'Orge"	1,934	0,460
	8400	47154	U renforcé	0,323	0,156
	8500	47177	Écharpe	0,647	0,267
	8600	47178	Barre	0,944	0,413
	8700	4802	Capot de barre et d'écharpe	0,170	0,104
	8800	47176	Battement central	0,563	0,201

Alu Design System

8000

DOUBLE LAME

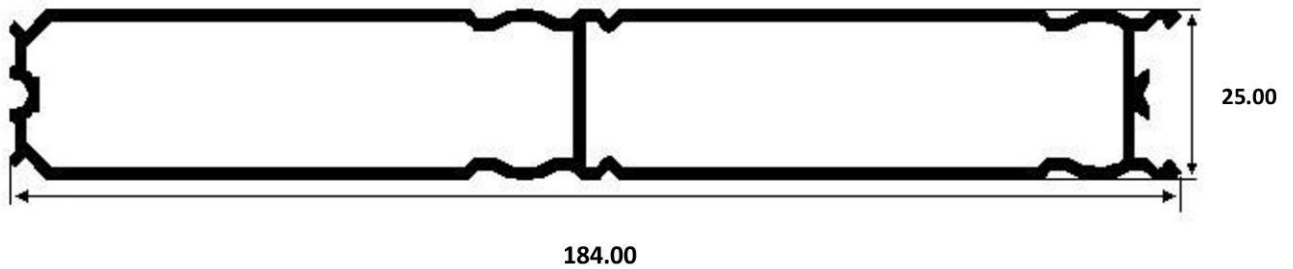

8100

DOUBLE LAME LISSE

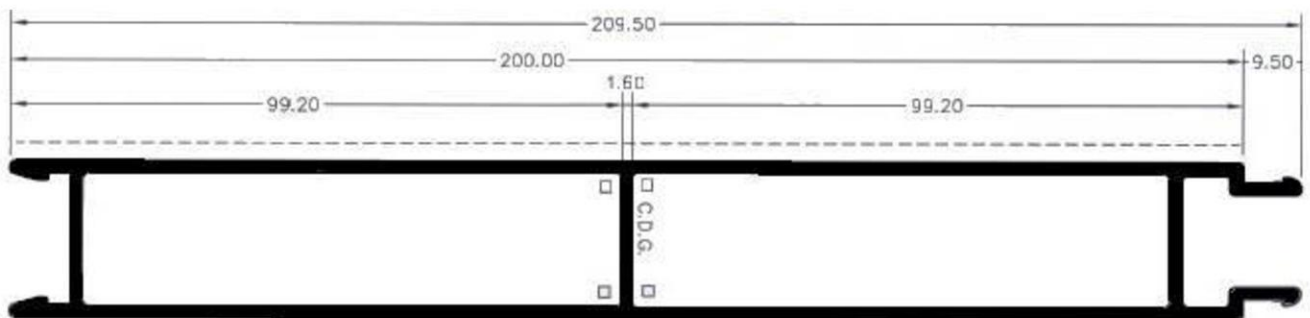

8110

LAME SIMPLE LISSE

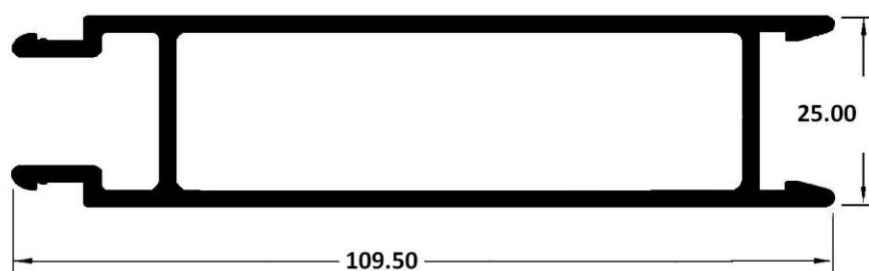

Alu Design System

8200

DOUBLE LAME de 180mm « GRAIN D'ORGE »

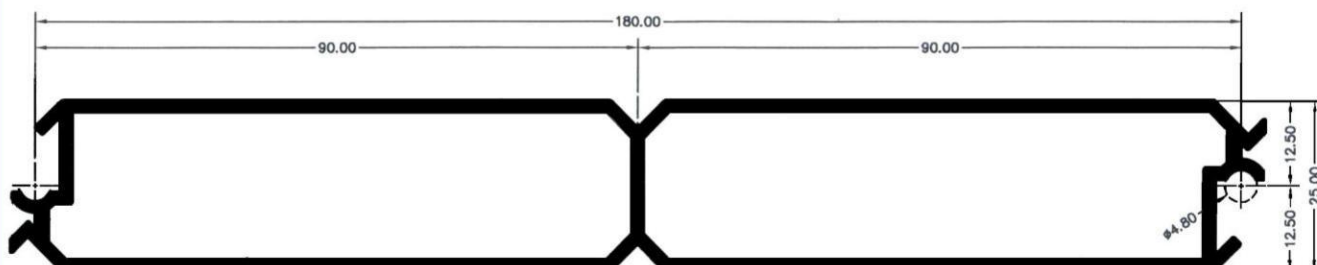

8600

BARRE

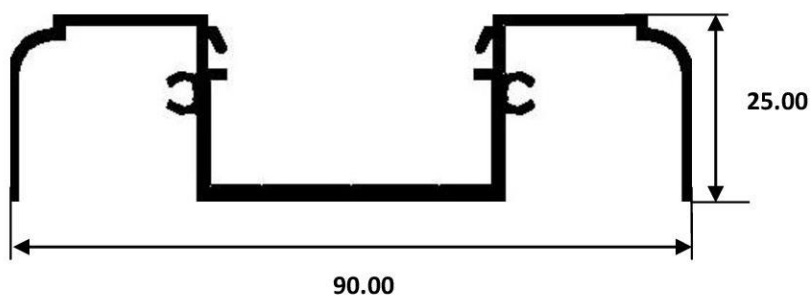

8400

U RENFORCÉ

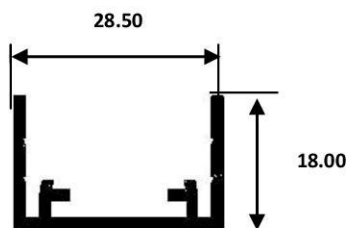

8410

U POUR VOLET BATTANT ISOLÉ

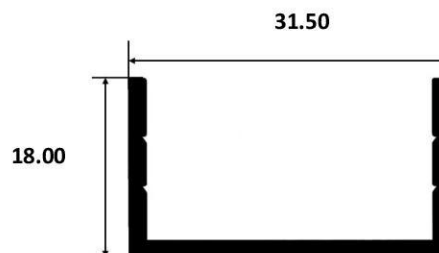

Alu Design System

8500

ÉCHARPE

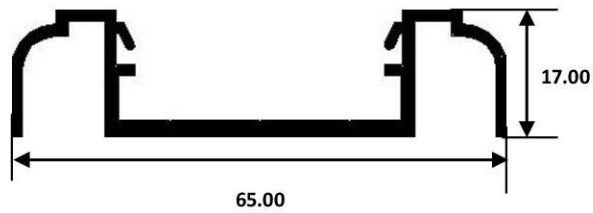

8700

CAPOT DE BARRE et ÉCHARPE

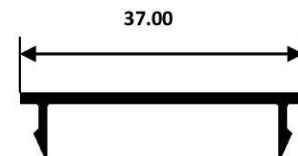

8800

BATTEMENT CENTRAL

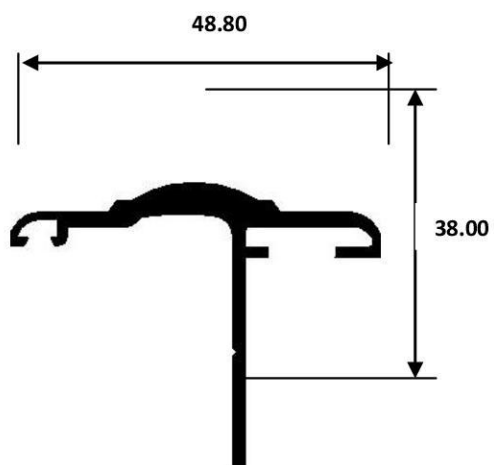



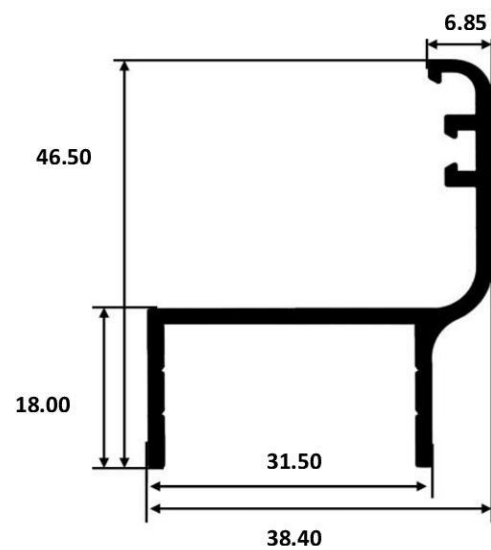

8810

U de VOLET BATTANT
BATTEMENT INTÉGRÉ

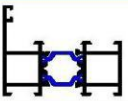
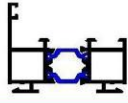
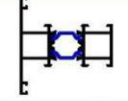
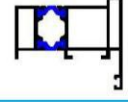
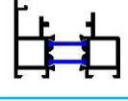
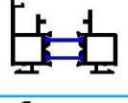
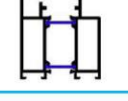
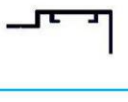
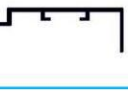
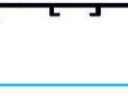

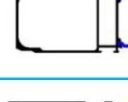
Série 9000 - Profils Cintrables

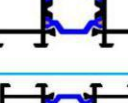
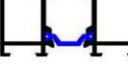
SILHOUETTE	RÉFÉRENCE ADS	RÉFÉRENCE TOLEDO	DÉSIGNATION	POIDS	PERIMÈTRE
	9000	34061	Dormant plat Série 55mm - Cintrable	1,001	0,313
	9100	34062	Dormant double clips Série 55mm - Cintrable	1,026	0,319
	9300	34063	Traverse pivotant Série 55mm - Cintrable	1,093	0,360
	9400	34064	Inverseur pivotant Série 55mm - Cintrable	1,173	0,270
	9500	34076	Petit dormant plat porte d'entrée Série 55mm - Cintrable	1,079	0,352
	9510	34077	Petit dormant porte d'entrée double clips - Série 55mm - Cintrable	1,226	0,360
	9520	34046	Gros dormant plat porte d'entrée Série 55mm - Cintrable	1,664	0,399
	9600	47085	Tapée cintrable pour isolation 100mm Cintrable	0,528	0,206
	9610	47086	Tapée cintrable pour isolation 120mm Cintrable	0,647	0,246
	9620	47087	Tapée cintrable pour isolation 140mm Cintrable	0,765	0,286
	9630	47088	Tapée cintrable pour isolation 160mm Cintrable	0,884	0,326
	9700	34051	Raidisseur 60mm Série 55mm - Cintrable	2,719	0,471
	9710	34050	Raidisseur 40mm Série 55mm - Cintrable	2,118	0,401
	9720	34052	Réhausse 28mm Série 55mm - Cintrable	0,916	0,272
	9730	34053	Réhausse 40mm Série 55 - Cintrable	1,130	0,296

suite... Série 9000

SILHOUETTE	RÉFÉRENCE ADS	RÉFÉRENCE TOLEDO	DÉSIGNATION	POIDS	PERIMÈTRE
	9740	34054	Réhausse 60mm Série 55mm - Cintrable	1,474	0,336
	9750	34078	Réhausse 100mm Série 55mm - Cintrable	2,166	0,413
	9000-50	34080	Dormant plat Série 50mm - Cintrable	1,001	0,304
	9100-50	34081	Dormant double clips Série 50mm - Cintrable	1,026	0,310
	9300-50	34082	Traverse pivotant Série 50mm - Cintrable	1,093	0,351
	9400-50	34083	Inverseur pivotant Série 50mm - Cintrable	1,173	0,263

Alu Design System

9000

DORMANT PLAT
Série 55 - Cintrable

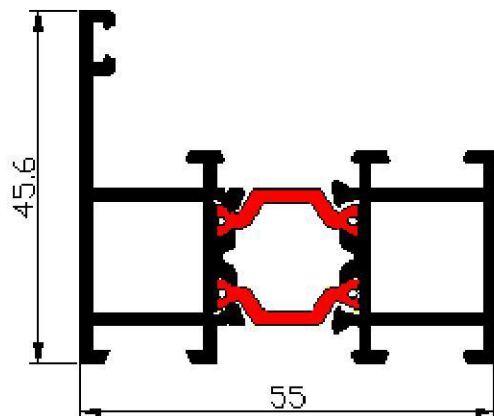

9100

DORMANT DOUBLE CLIPS
Série 55 - Cintrable

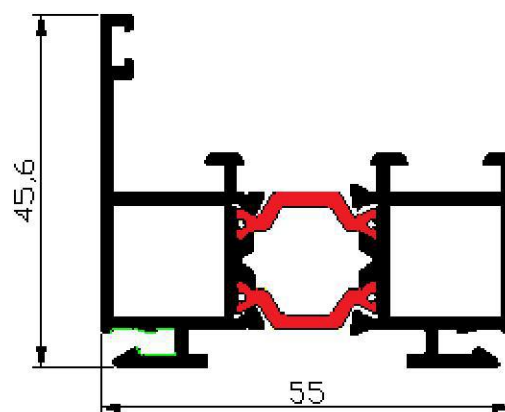

9300

TRAVERSE PIVOTANT
Série 55 - Cintrable

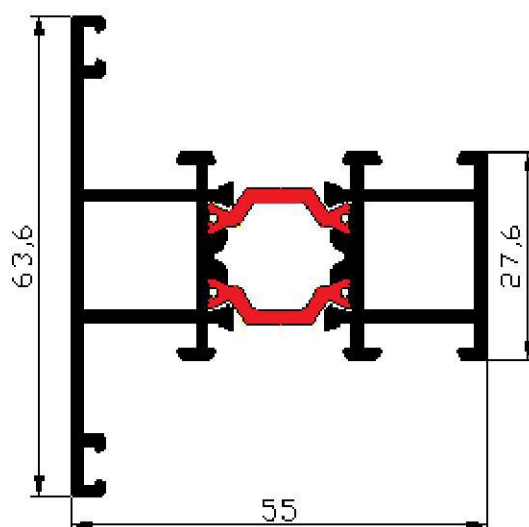

9400

INVERSEUR PIVOTANT
Série 55 - Cintrable

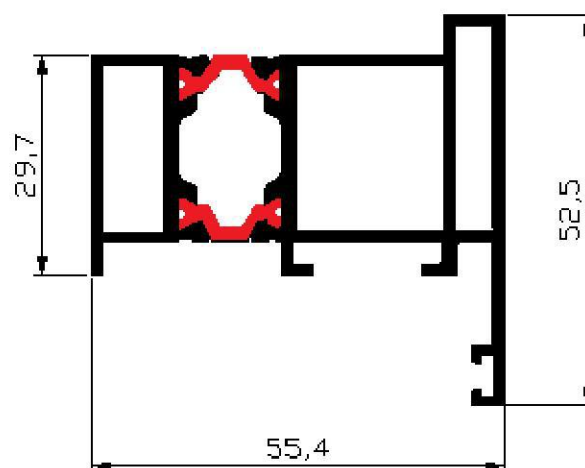

Alu Design System

9000-50

DORMANT PLAT
Série 50 - Cintrable

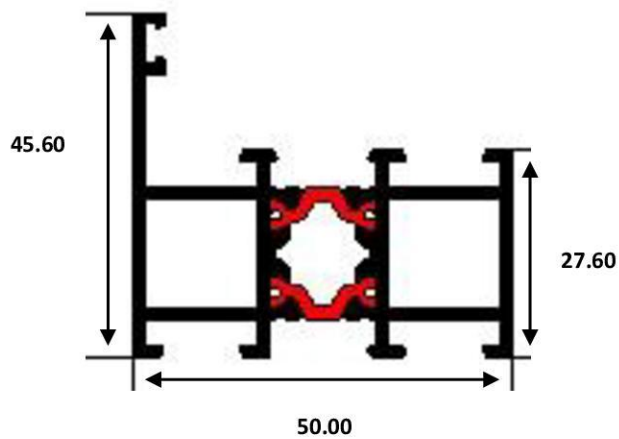

9100-50

DORMANT DOUBLE CLIPS
Série 50 - Cintrable

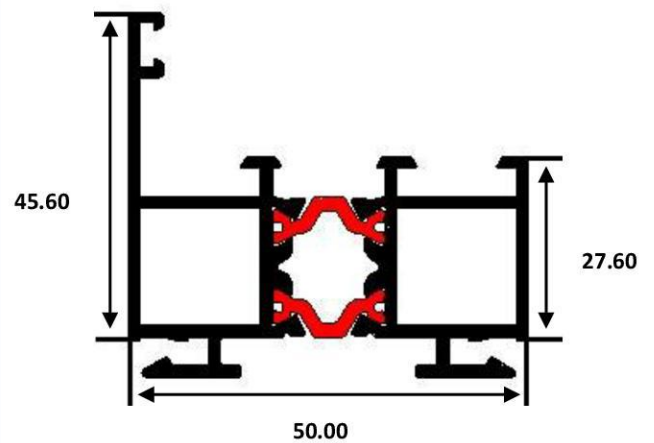

9300-50

TRAVERSE PIVOTANT
Série 50 - Cintrable

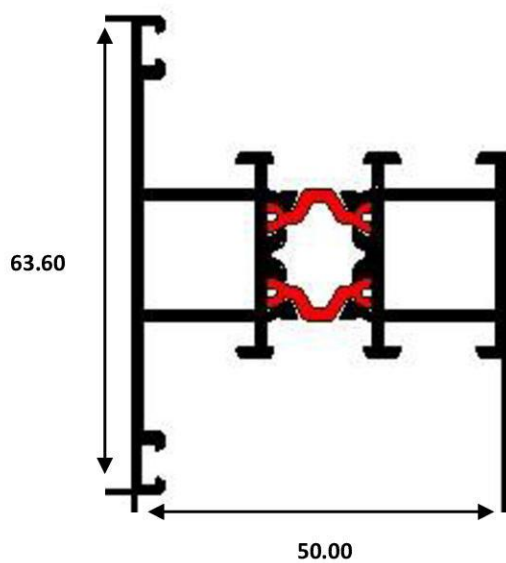

9400-50

INVERSEUR PIVOTANT
Série 50 - Cintrable

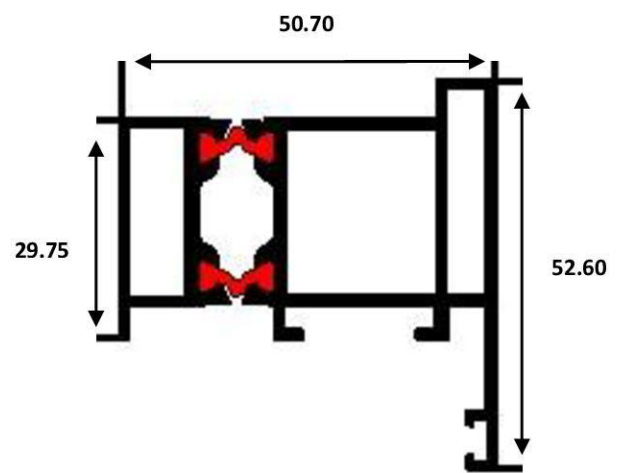

Alu Design System

9500

PETIT DORMANT PORTE
d'ENTRÉE PLAT
Série 55 - Cintrable

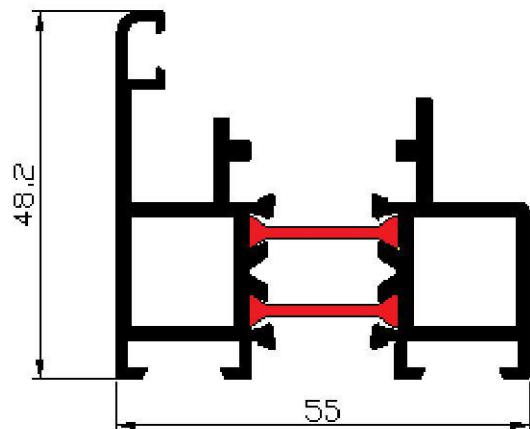

9510

PETIT DORMANT PLAT PORTE
D'ENTRÉE DOUBLE CLIPS
Série 55 - Cintrable

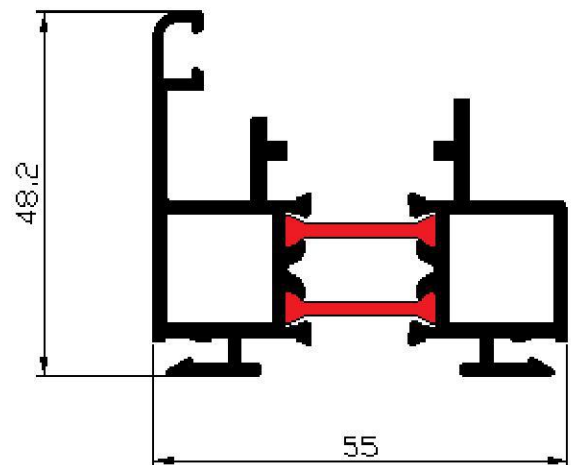

9520

GROS DORMANT PORTE D'ENTRÉE
Série 55 - Cintrable

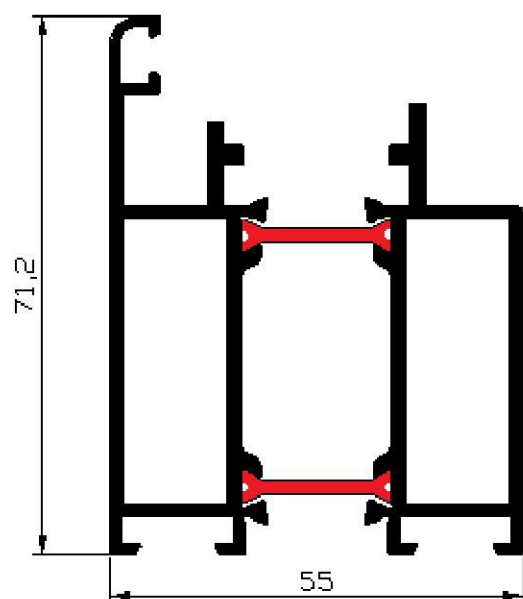

Alu Design System

9600

TAPÉE CINTRABLE POUR ISOLATION de 100mm

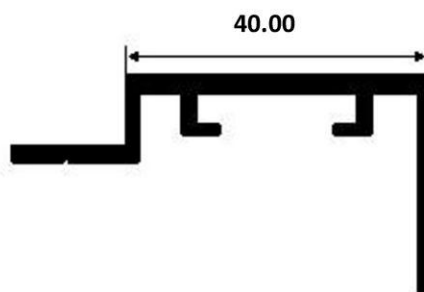

9610

TAPÉE CINTRABLE POUR ISOLATION de 120mm

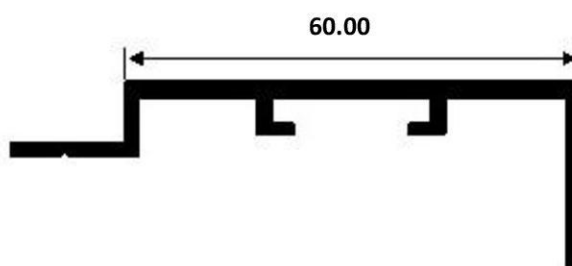

9620

TAPÉE CINTRABLE POUR ISOLATION de 140mm

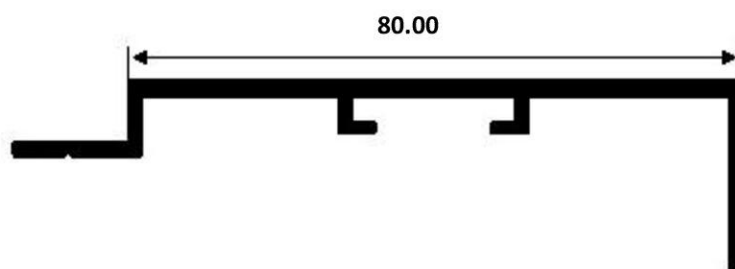

9630

TAPÉE CINTRABLE POUR ISOLATION de 160mm

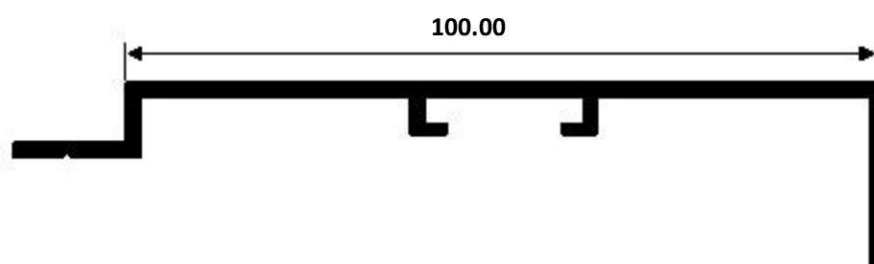

Alu Design System

9700

RAIDISSEUR 60mm - Série 55 - Cintrable

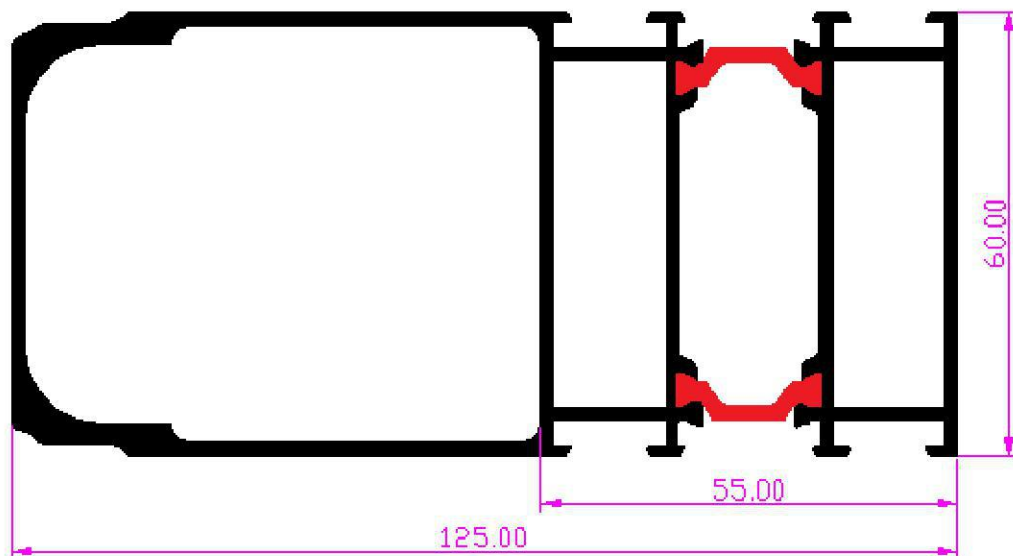

9710

RAIDISSEUR 40mm - Série 55 - Cintrable

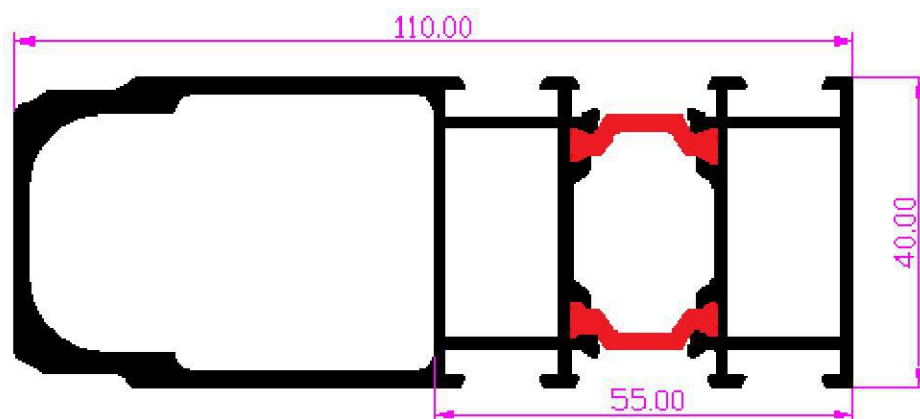

Alu Design System

9720

RÉHAUSSE 28 mm
Série 55 - Cintrable

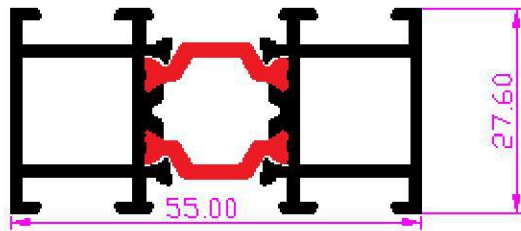

9730

RÉHAUSSE 40mm
Série 55 - Cintrable

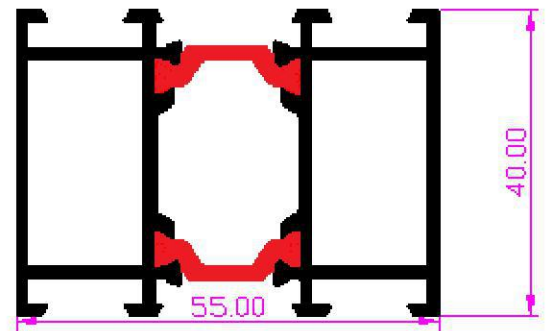

9740

RÉHAUSSE 60mm
Série 55 - Cintrable

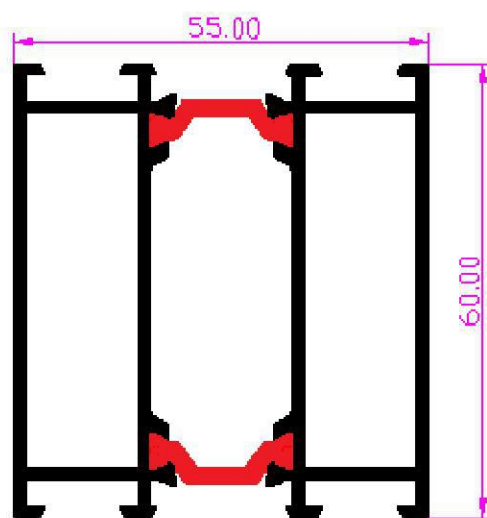

9750

RÉHAUSSE 100mm
Série 55 - Cintrable

