

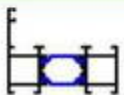

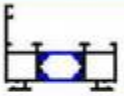

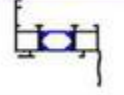





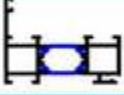

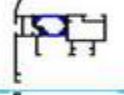
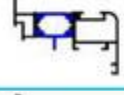
Série 1000 - Châssis à frappe

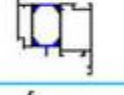
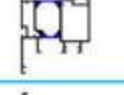
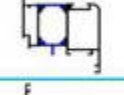
SILHOUETTE	RÉFÉRENCE ADS	RÉFÉRENCE TOLEDO	DÉSIGNATION	POIDS	PERIMÈTRE
	1000	34047	Dormant plat	1,027	0,335
	1010	34037	Dormant double clips	1,052	0,341
	1020	34048	Dormant couvre-joint intégré	1,131	0,386
	1030	34049	Dormant rénovation	1,254	0,429
	1040	34102	Dormant Clip Intérieur - Plat Extérieur	1,038	0,337
	1100	34042	Ouvrant fenêtre mouluré en Z	1,200	0,382
	1110	34038	Ouvrant fenêtre mouluré en T	1,525	0,480
	1200	34043	Ouvrant droit fenêtre en Z	1,189	0,371
	1210	34039	Ouvrant droit fenêtre en T	1,513	0,472
	1300	34044	Ouvrant porte fenêtre mouluré en Z	1,618	0,428
	1310	34040	Ouvrant porte fenêtre mouluré en T	1,946	0,529
	1400	34045	Ouvrant droit porte fenêtre en Z	1,607	0,417
	1410	34041	Ouvrant droit porte fenêtre en T	1,934	0,518
	1600	34106	Châssis à l'italienne Dormant plat	0,988	0,287
	1610	34107	Châssis à l'italienne Dormant double clips	1,016	0,294
	1620	34108	Châssis à l'italienne Ouvrant de fenêtre	1,406	0,394
	1700	34023	Traverse 72mm	1,143	0,395

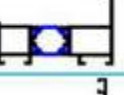
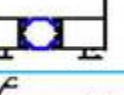
suite... Série 1000

SILHOUETTE	RÉFÉRENCE ADS	RÉFÉRENCE TOLEDO	DÉSIGNATION	POIDS	PERIMÈTRE
	1710	34025	Traverse 84mm	1,357	0,420
	1720	34022	Traverse 104mm	1,702	0,460
	1730	34059	Traverse 144mm	2,393	0,538
	1740	34090	Traverse pour Trapèze 84mm	1,357	0,438
	1000-50	34087	Dormant plat Série 50mm	1,027	0,316
	1010-50	34086	Dormant double clips Série 50mm	1,052	0,322
	1000-55	34088	Dormant plat Série 55mm	1,027	0,325
	1010-55	34089	Dormant double clips Série 55mm	1,052	0,330

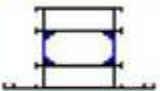
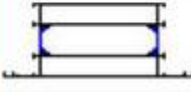
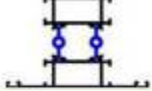
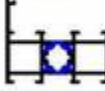
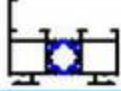
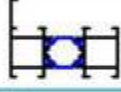
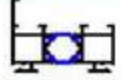
Série Froide

1000 - Châssis à frappe

SILHOUETTE	RÉFÉRENCE ADS	RÉFÉRENCE TOLEDO	DÉSIGNATION	POIDS	PERIMÈTRE
	1000FR	47140	Série Froide Dormant plat	0,996	0,322
	1010FR	47141	Série Froide Dormant double clips	0,991	0,327
	9800FR	47139	Série Froide Cloisir de 55mm	0,356	0,177

Alu Design System

1000

DORMANT PLAT

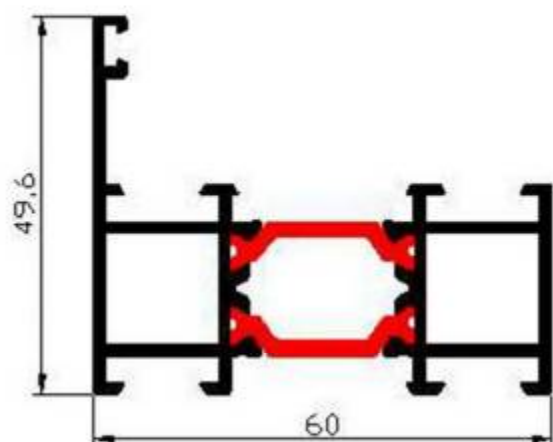

1010

DORMANT DOUBLE CLIPS

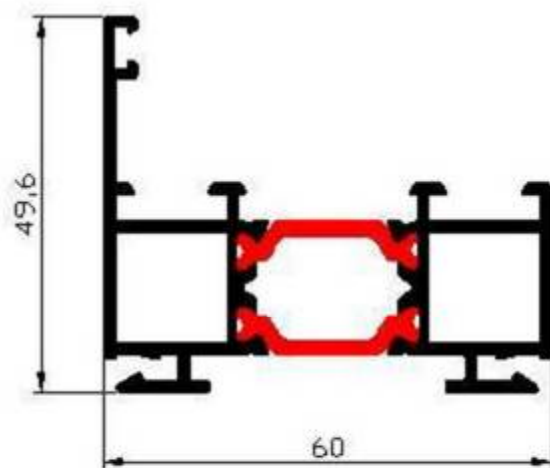

1020

DORMANT COUVRE-JOINT
INTÉGRÉ

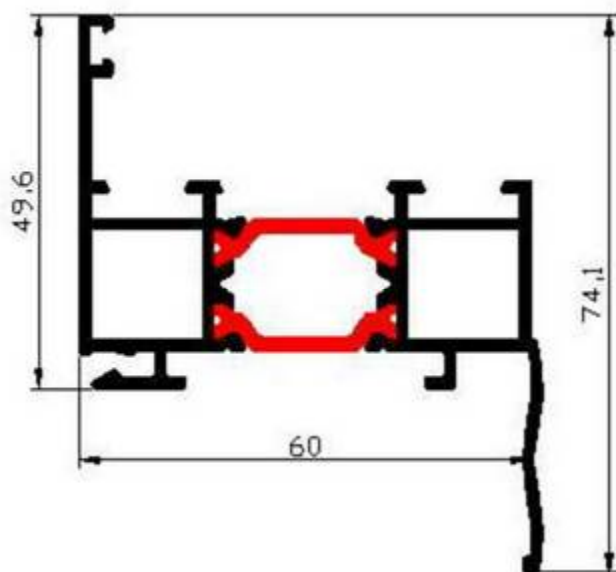

INDISPONIBLE

1030

DORMANT RÉNOVATION

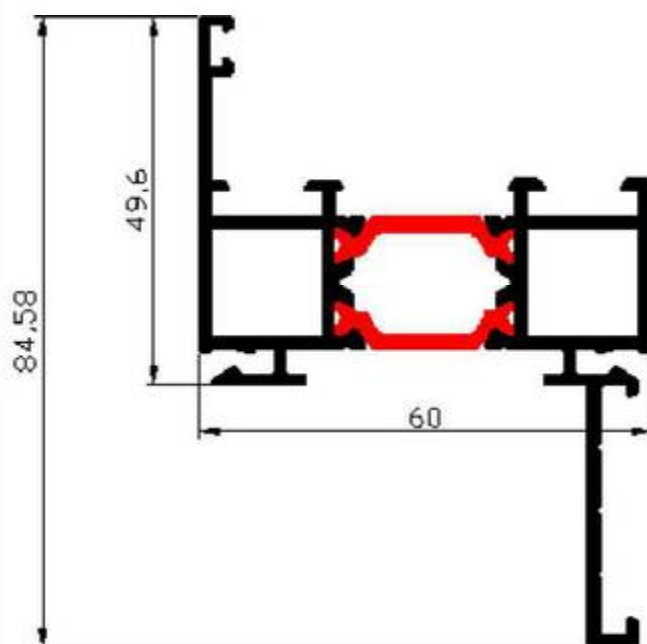

Alu Design System

1040

DORMANT
Clip Intérieur - Plat Extérieur

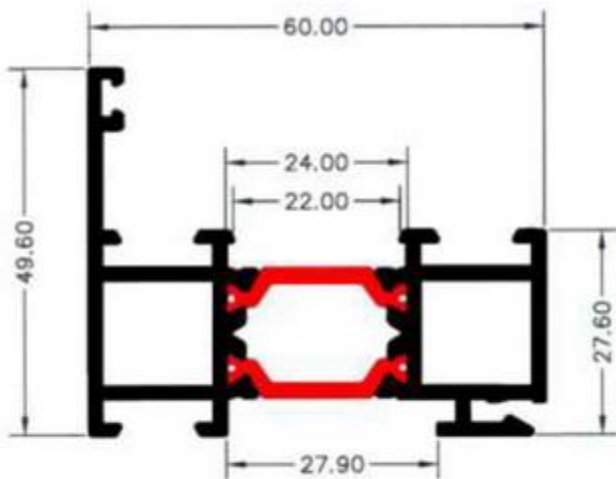

INDISPONIBLE

Alu Design System

1000-50

DORMANT PLAT
Série 50

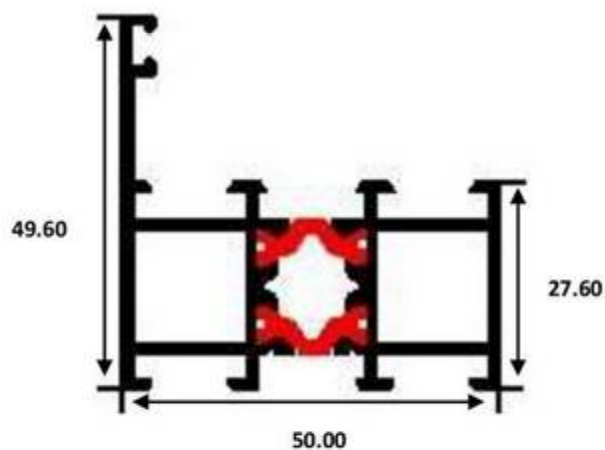

1010-50

DORMANT DOUBLE CLIPS
Série 50

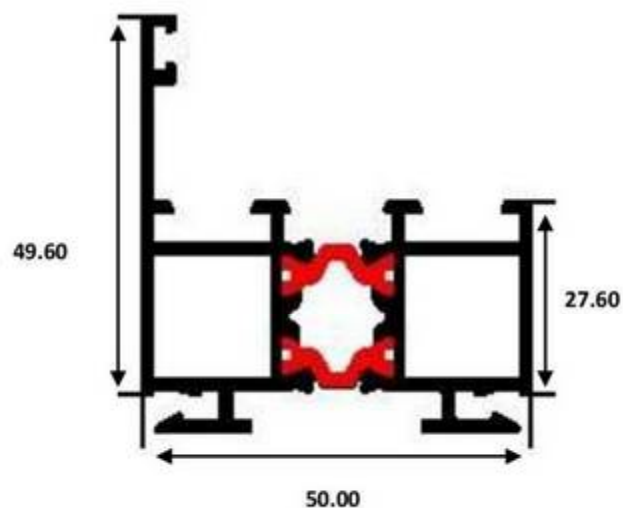

1000-55

DORMANT PLAT
Série 55

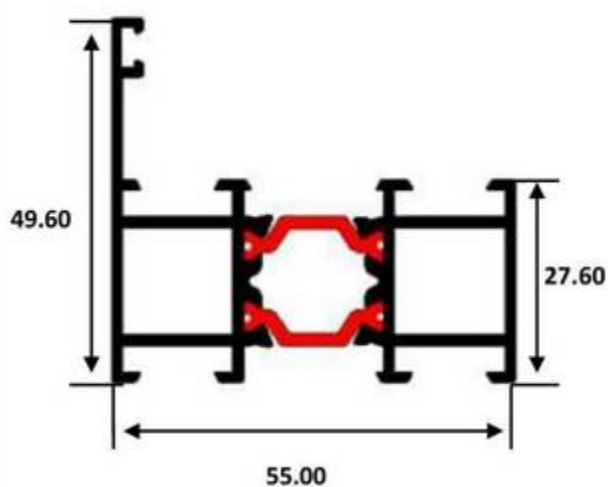

1010-55

DORMANT DOUBLE CLIPS
Série 55

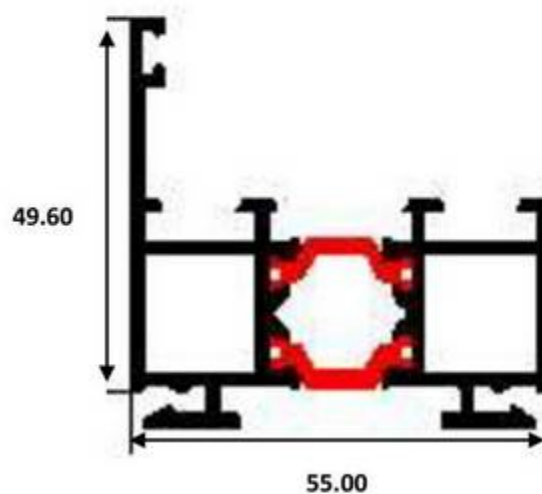

Alu Design System

1100

OUVRANT FENÊTRE
MOULURÉ en Z

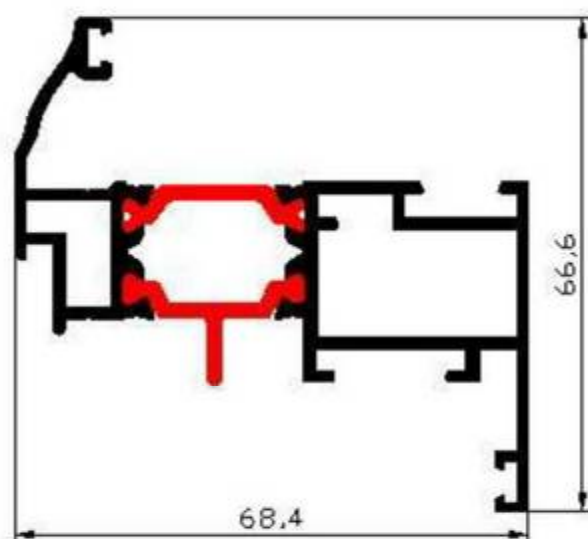

1110

OUVRANT FENÊTRE
MOULURÉ en T

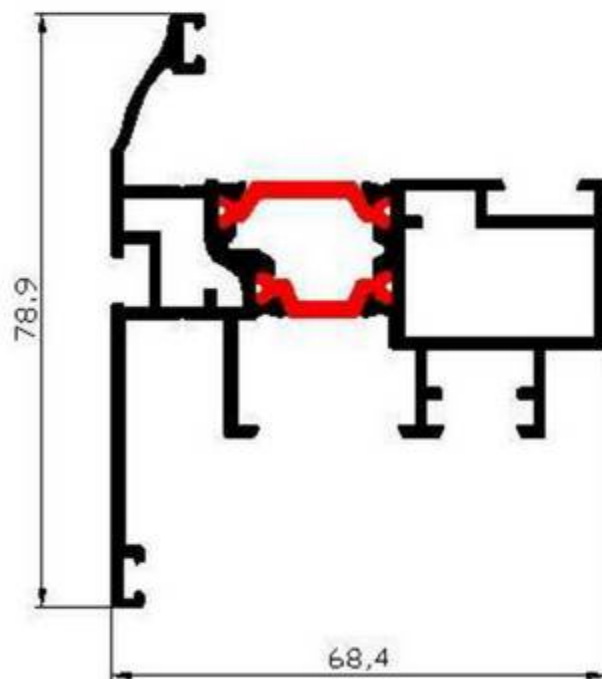

1200

OUVRANT DROIT
FENÊTRE en Z

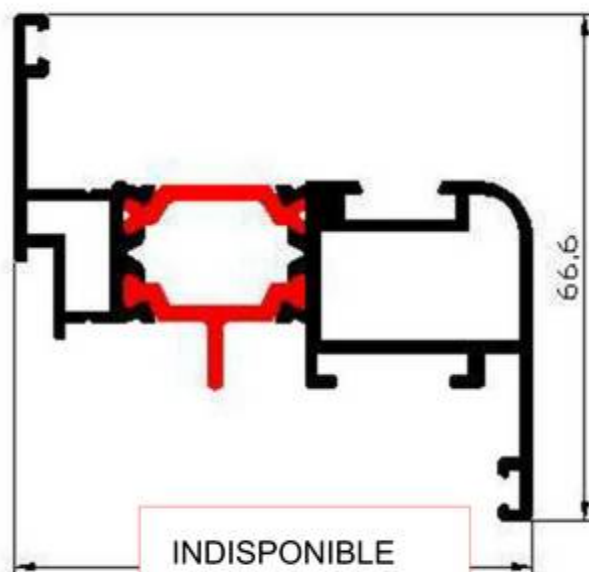

1210

OUVRANT DROIT
FENÊTRE en T

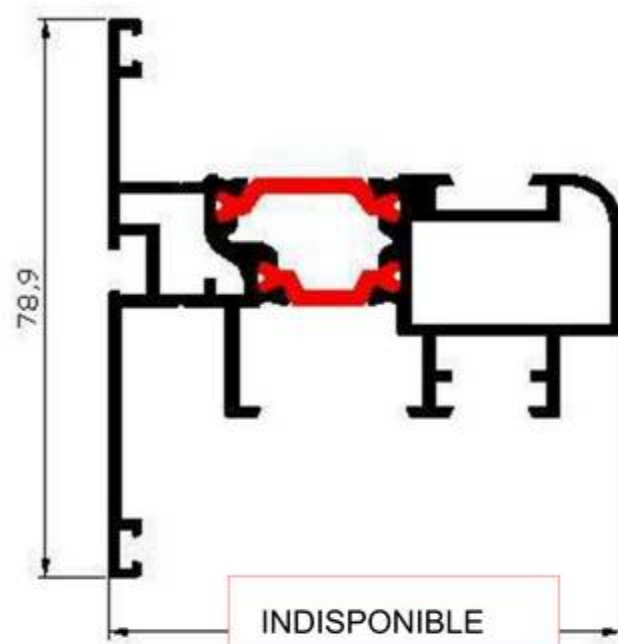

Alu Design System

1300

OUVRANT PORTE FENÊTRE MOULURÉ en Z

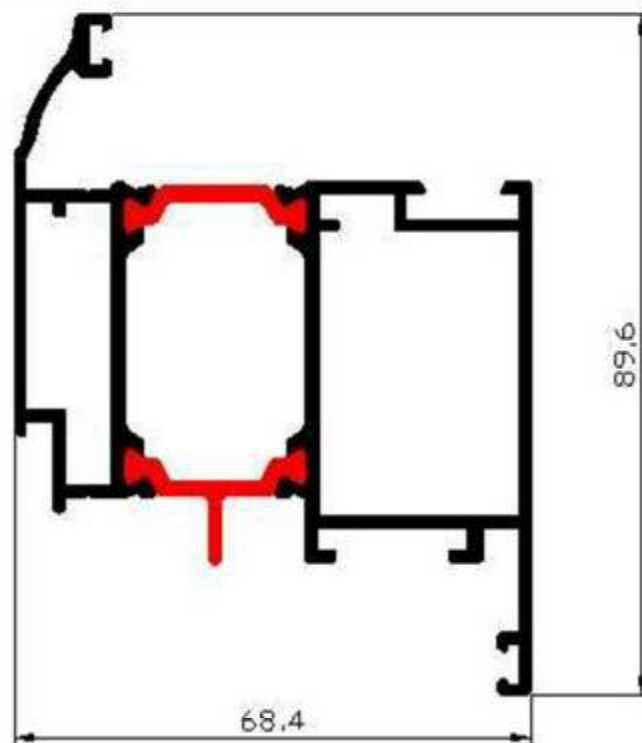

1310

OUVRANT PORTE FENÊTRE MOULURÉ en T

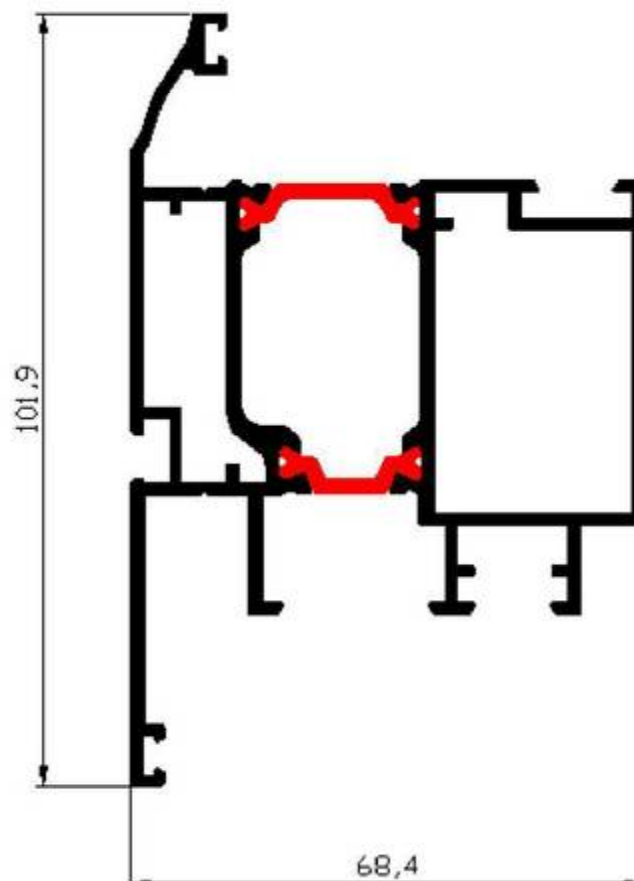

Alu Design System

1400

OUVRANT DROIT PORTE FENÊTRE en Z

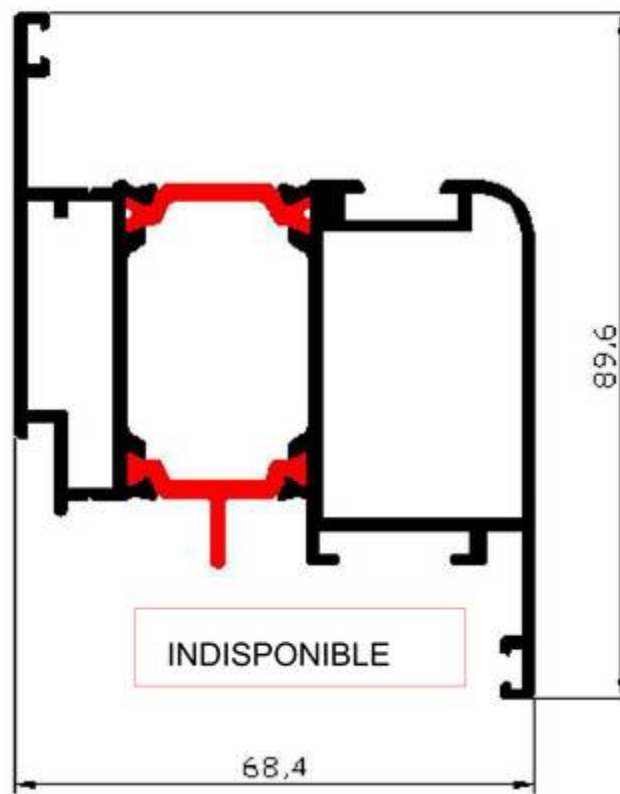

1410

OUVRANT DROIT PORTE FENÊTRE en T

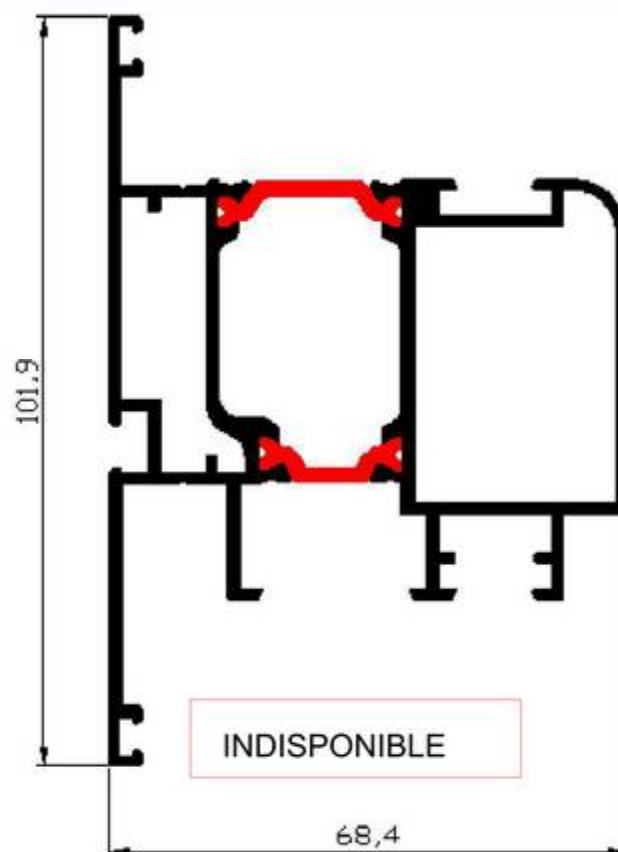

Alu Design System

1600

CHÂSSIS À L'ITALIENNE
DORMANT PLAT

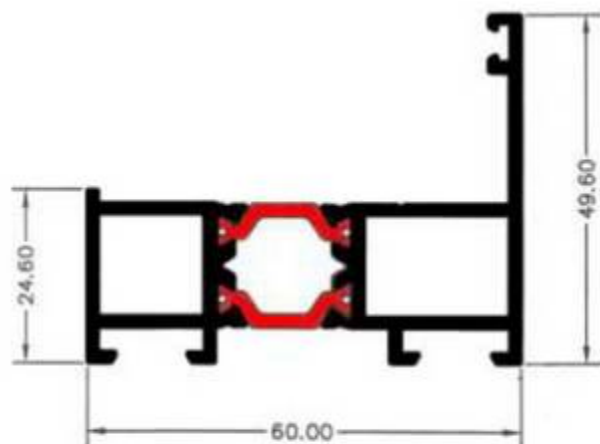

1610

CHÂSSIS À L'ITALIENNE
DORMANT DOUBLE CLIPS

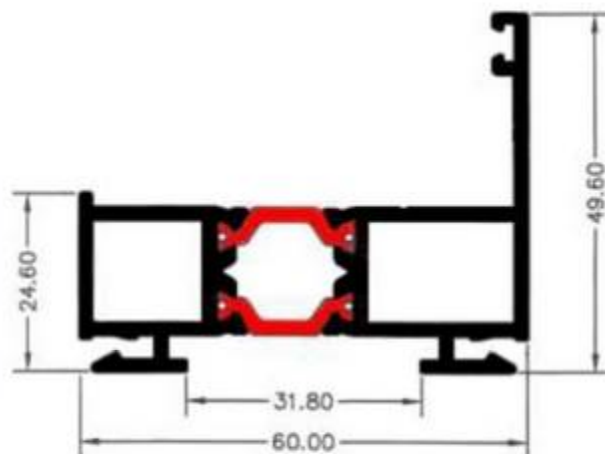

1620

CHÂSSIS À L'ITALIENNE
OUVRANT DE FENÊTRE EN T

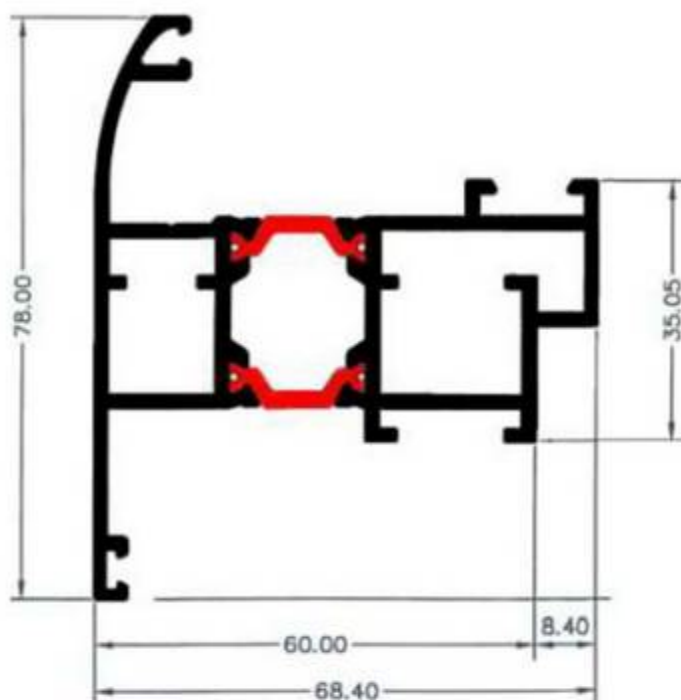

Alu Design System

1700

TRAVERSE 72mm

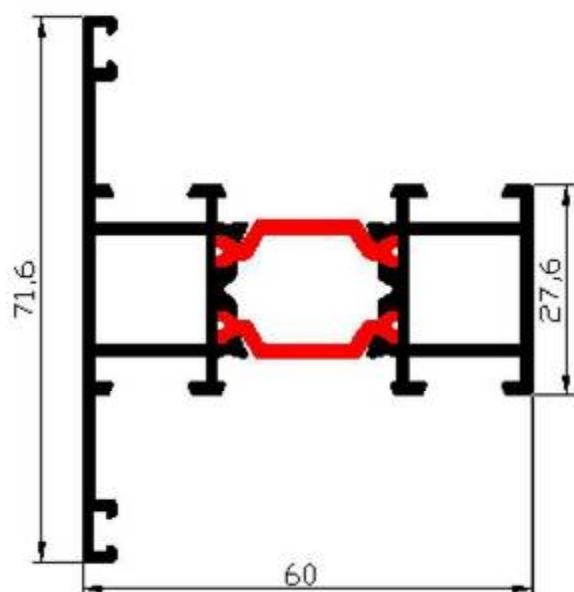

1710

TRAVERSE 84mm

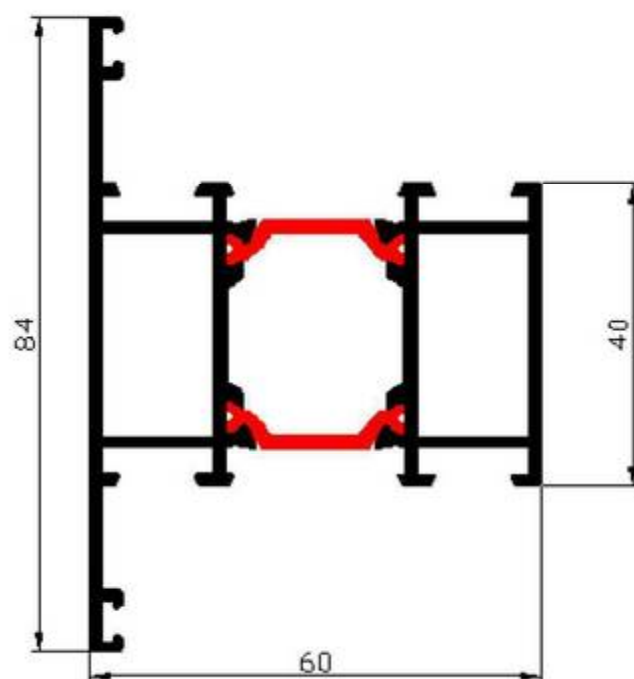

1740

TRAVERSE 84mm
avec alvéolis

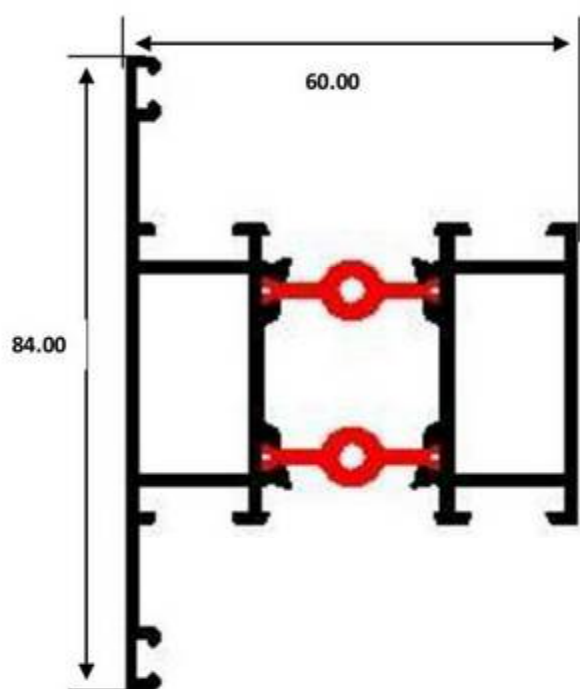

Alu Design System

1720

TRAVERSE 104mm

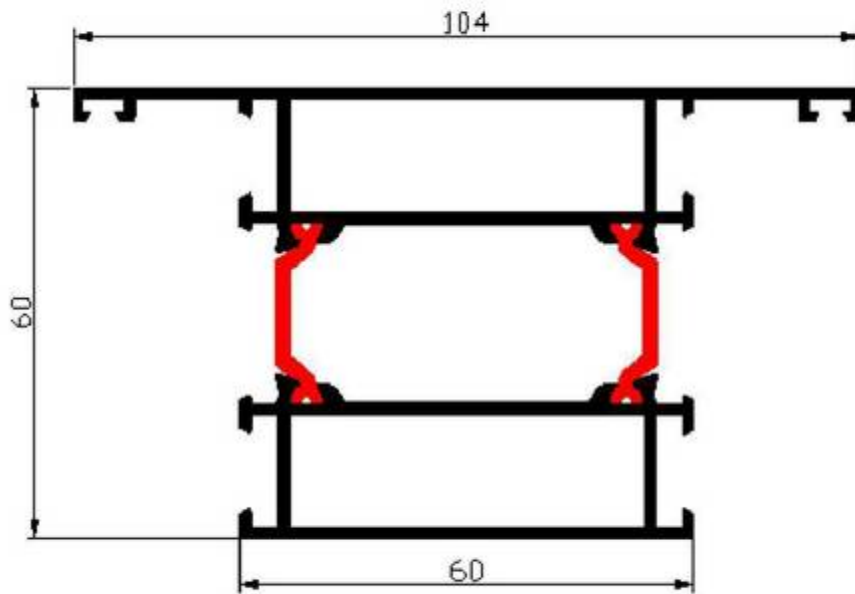

1730

TRAVERSE 144mm

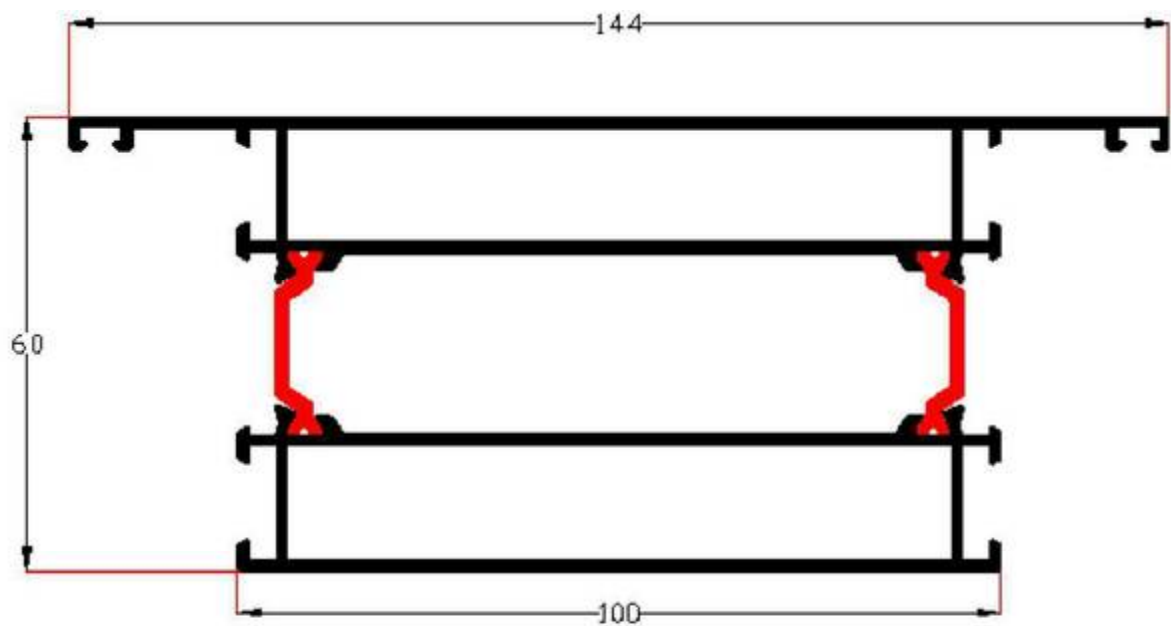

Alu Design System

1000-fr

DORMANT PLAT

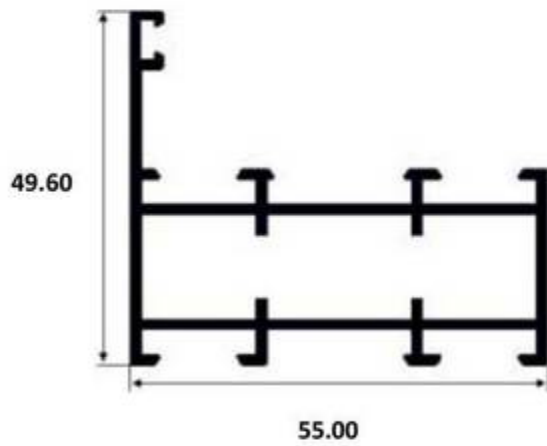

1010-fr

DORMANT DOUBLE CLIPS

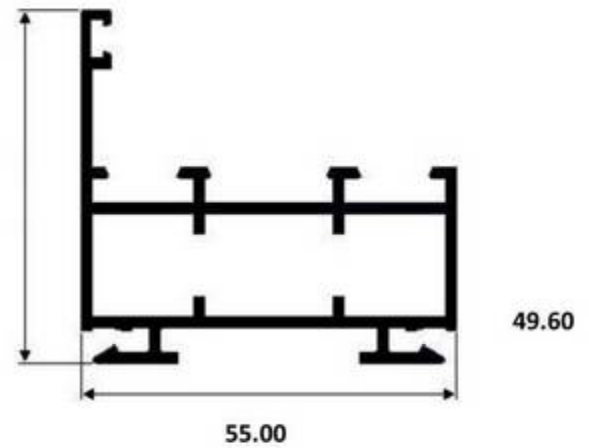

9800-fr

CLOSOIR de 55mm

